

## CHAPTER 9

# RADIO COMMUNICATION EQUIPMENT

This chapter presents the elementary principles of operation for radio equipment. It is meant to be studied in conjunction with the Navy Training Courses Basic Electricity, NavPers 10086-A, and Basic Electronics, NavPers 10087-A. You will find the chapters applicable to Radiomen in the reading list at the front of this manual.

In the descriptions of representative communication equipments, only the fundamental features are given. The circuits are represented largely by block diagram, and the emphasis is on the types and purposes of the stages on which the performance capabilities and limitations of the equipment are based. Because detailed schematic drawings and exact descriptions of all the various elements cannot be given here, the reader is referred to the equipment technical manuals for information pertaining to the circuit details.

Before going into the study of transmitters and receivers, let us first review the subject of electrical units, and the schematic symbols used in electronic circuit drawings.

### ELECTRICAL UNITS

A thorough knowledge of the electrical units presented in Ohm's law is a necessity for the Radioman. The coverage given these units in the following paragraphs is intended as a review only. Unless you are familiar with their application in Ohm's law, you are advised again to study the Navy Training Courses entitled Basic Electricity and Basic Electronics.

### CURRENT

An electrical current is often compared to the flow of water through a main. To gage the rate of flow we must have a measure of quantity (pints, quarts, gallons, barrels, etc.) and a measure of time (seconds, minutes, hours, etc.).

In an electrical circuit the current that flows is composed of electrons, which are tiny charged particles that form one of the constituent parts of atoms. The electron is far too small to serve as a measure of quantity, and a larger unit, the COULOMB—6.3 billion billion electrons—is used instead. The measure of time is the second. A flow of 1 coulomb per second is equal to 1 AMPERE, a term that is at the same time a measure of quantity and time, just as the term KNOT is a measure of both distance and time.

### VOLTAGE AND RESISTANCE

Assume that a water main is fed from a standpipe some miles away. Water flows because the water level in the standpipe is higher than the outlet of the main, and the difference in their levels causes a pressure to be exerted on water in the main.

The movement of electricity is comparable. If there is a difference in the relative electrical level (charge) between two terminals of the conductor, electrons move from the point of relative surplus (negative terminal) to the point of relative shortage (positive terminal), and a current flows. This difference in electrical level is termed DIFFERENCE IN POTENTIAL, and may also be thought of as pressure. It is measured in VOLTS. An electrical conductor offers resistance to the flow of current just as the inside surface of the main offers resistance to the flow of water. Electrical resistance is measured in OHMS. To force 1 ampere through a resistance of 1 ohm requires a pressure of 1 volt.

### POWER

Power, the TIME RATE of doing work, is the product of voltage and amperage. The elec-

trical unit of power, the WATT, is the product of 1 volt and 1 ampere.

### SCHEMATIC SYMBOLS

At this point it would be profitable for you to become familiar with the various schematic symbols you will encounter in both your study and your work with electrical and electronic circuits. These graphic symbols represent a shorthand method used by designers and engineers on electronic circuit drawings.

In recent years many changes have resulted from efforts by Government activities and the electronic industry to standardize these circuit symbols. Consequently, you will find many textbooks and equipment technical manuals, prepared before adoption of the standard, in which some symbols are not quite identical with those shown in this manual. However, in most instances, familiarity with the modern standard enables you to recognize easily the intent of the older symbols.

The list of symbols shown in figure 9-1, while not all-inclusive, illustrates most of the basic symbols of interest to the Radioman, and also includes many typical combinations, called buildup symbols. It can be truthfully said that a complete listing of all possible buildup examples has never been compiled. A reasonably comprehensive knowledge of the basic symbols, however, will enable you to understand the more complex buildups. You should know particularly, in your study of electronic circuits, that schematic symbols may be drawn to any proportional size that suits a particular drawing, and may be oriented in any direction without altering the meaning of the symbols. Explanatory details are often added, when necessary, adjacent to the symbols.

Your work as a Radioman requires that you know the meanings of these schematic symbols and be able to identify, in schematic diagrams, certain basic radio circuits, such as amplifiers, oscillators, mixers, and rectifiers. These circuits are schematically illustrated and discussed in detail in Basic Electronics, NavPers 10087-A.

As you advance in rating beyond RM2, you will find increased uses for your knowledge of schematic symbols in reading and interpreting circuit diagrams and in understanding special circuits of increased complexity used in Navy communication equipment.

### EQUIPMENT DESIGNATING SYSTEMS

A nameplate on the front of each item of electronic equipment carries a group of letters and numbers to identify the equipment. This group is assigned in accordance with either the Joint Electronics Type Designation System (commonly called AN nomenclature system) or the Navy Model System, depending upon the relative age of the equipment. Most new electronic equipment procured for the Navy, Army, Air Force, Marine Corps, and Coast Guard is assigned model letters under the Joint Electronics Type Designation System.

#### JOINT ELECTRONICS TYPE DESIGNATION SYSTEM

The first two letters of the Joint Electronics Type Designation System are AN. This is the system indicator. It does not mean that all the services use the equipment, but only that the type number was assigned under the AN system. The AN is followed by a slant sign and three identifying letters. The letters to the right of the slant sign are very important, for they give a brief description of the equipment:

**FIRST LETTER**—Where installed; whether designed for use in aircraft, submarine, surface craft, shore station, etc.

**SECOND LETTER**—Type of equipment; radio, radar, sonar, visual, etc.

**THIRD LETTER**—Purpose of the equipment; communications, direction-finding, receiving, transmitting, etc.

The three equipment indicator letters are followed by the model number, and the model number may be followed by additional letters to indicate a modification of the original equipment.

For an example, take the equipment designation AN/SRT-15. The AN is the system indicator. A glance at table 9-1 gives us the meaning of the equipment indicator letters:

S—Water surface craft.

R—Radio.

T—Transmitting.

The figure 15 is the model number.

#### NAVY MODEL SYSTEM

The AN nomenclature system was adopted by the Navy in 1946, but you still find a considerable amount of equipment marked and identified by the older Navy Model System.

# Chapter 9 – RADIO COMMUNICATION EQUIPMENT

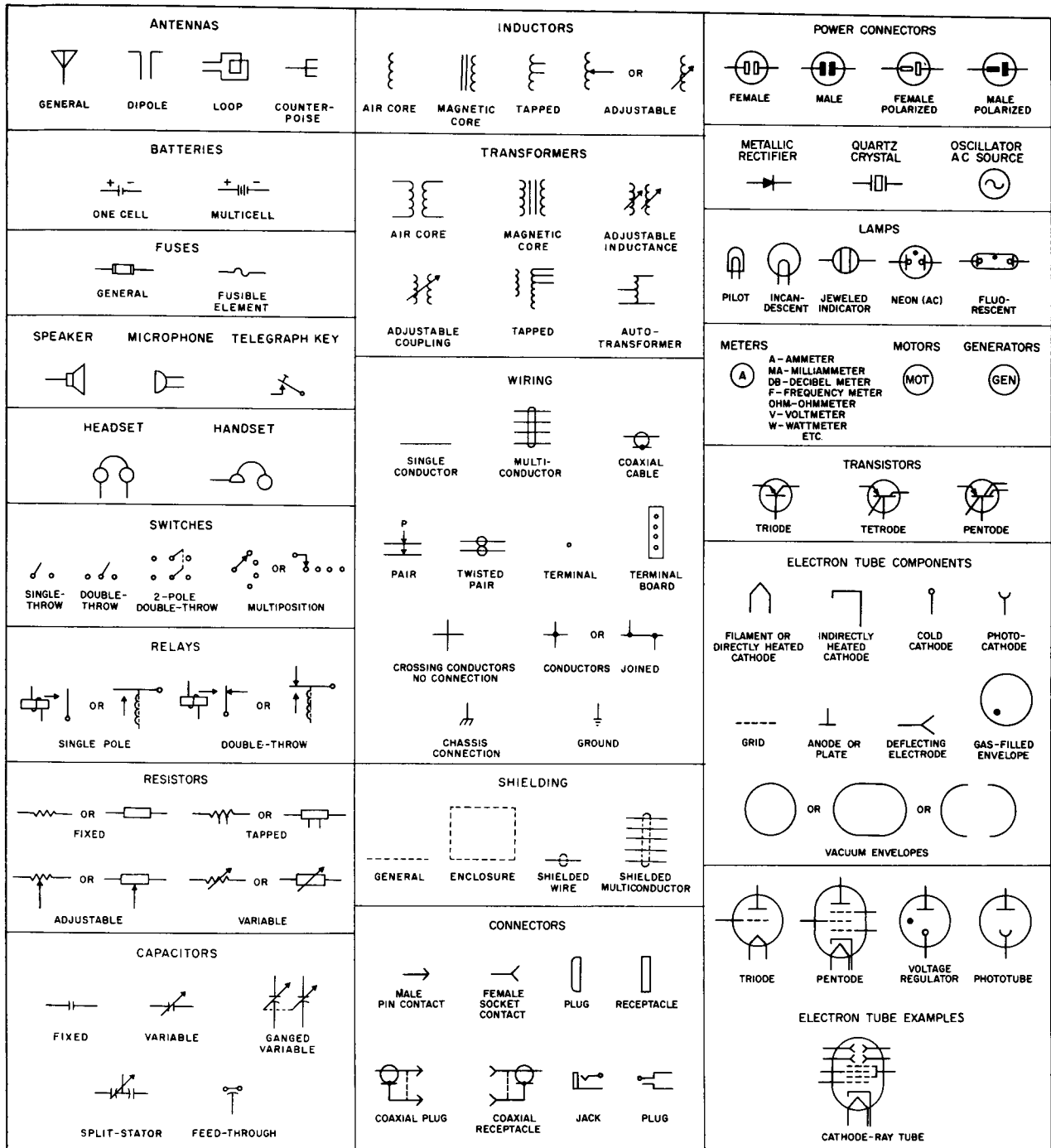

13.5A

Figure 9-1. —Schematic symbols.

Table 9-1. — Equipment Indicator Letters, a Nomenclature System

1st letter (designed installation classes)	2d letter (type of equipment)	3d letter (purpose)
INSTALLATION	TYPE OF EQUIPMENT	PURPOSE
A—Airborne (installed and operated in aircraft).	A—Invisible light, heat radiation.	A—Auxiliary assemblies (not complete operating sets).
B—Underwater mobile, submarine.	B—Pigeon.	B—Bombing.
C—Air transportable (inactivated).	C—Carrier.	C—Communications (receiving and transmitting).
D—Pilotless carrier.	D—Radiac.	D—Direction finder and/or reconnaissance.
F—Fixed.	E—Nupac (nuclear protection and control).	E—Ejection and/or release.
G—Ground, general ground use.	F—Photographic.	G—Fire control or searchlight
K—Amphibious.	G—Telegraph or teletype.	H—Recording and/or reproducing (graphic, meteorological, and sound).
M—Ground, mobile (installed as operating unit in a vehicle which has no function besides transporting the equipment).	I—Interphone and public address	L—Searchlight control (inactivated; use G).
P—Pack or portable (animal or man).	J—Electromechanical (not otherwise covered).	M—Maintenance and test assemblies (including tools).
S—Water surface craft.	K—Telemetering.	N—Navigational aids (including altimeters, beacons, compasses, racons, depth sounding, approach, and landing).
T—Ground, transportable.	L—Countermeasures.	P—Reproducing (inactivated).
U—General utility (includes two or more general installation classes, airborne, shipboard, and ground).	M—Meteorological.	Q—Special, or combination of purposes.
V—Ground, vehicular (installed in vehicle designed for functions other than carrying electronic equipment, etc., such as tanks).	N—Sound in air.	R—Receiving, passive detecting.
W—Water surface and underwater.	P—Radar.	S—Detecting and/or range and bearing.
	Q—Sonar and underwater sound.	T—Transmitting.
	R—Radio.	W—Control.
	S—Special types, magnetic, etc., or combinations of types.	X—Identification and recognition.
	T—Telephone (wire).	
	V—Visual and visible light.	
	W—Armament (peculiar to armament, not otherwise covered).	
	X—Facsimile or television.	

The assignment of Navy model letters to electronic equipment depends on the primary function of the equipment, such as receiving, transmitting, direction-finding, etc. In this system only the first letter (in a few instances, the first two letters) indicates the basic purpose of the equipment. The remaining letters were assigned in alphabetical sequence as newer equipments were designed. Some first letters you will find on equipment nameplates are:

- D—Radio direction-finding.
- FS—Frequency shift keying.
- L—Precision calibrating (such as frequency meters).
- R—Radio receiving.
- T—Radio transmitting (includes combination transmitting and receiving).

In the list you can see that the letter R means radio receiving. The first receiver designated under the system was RA, RB the second, and so on. When the alphabet was exhausted, 3-letter designators were used. For example, RAA followed RZ, then RAB followed RAA; RAZ was followed by RBA, and so on.

Numbers following the model letters indicate a modification of the equipment or the award of a new manufacturer's contract.

Although the Navy model letter system of equipment identification no longer is in primary use, you will find some equipments under this system of comparatively recent design and manufacture — for example, the model TED transmitter.

#### CLASSIFICATION OF EMISSIONS

Radio wave emissions (transmissions) have been classified by international agreement, depending on the type of modulation used. The classifications devised by the International Telecommunication and Radio Conference in 1938 included:

- A1—CW telegraphy.
- A2—Modulated telegraphy (MCW).
- A3—Telephony.
- A4—Facsimile.
- A5—Television.

The foregoing classification of emissions still is widely used, but is inadequate because there is no provision for such systems as frequency modulation, pulse-time modulation, frequency-shift keying, and multiplexing. The Ordinary Administrative Radio Conference at Geneva in 1959 adopted a system that is more comprehensive. This system classified emis-

sions according to type of modulation, type of transmission, bandwidth, and supplementary characteristics. Following are typical examples of the designators that are of interest to Radiomen:

- 0.1A1 CW telegraph, 25 wpm.
- 2.04A2 CW telegraph, tone-modulated, 1020 cycle tone.
- 6A3 AM telephony.
- 36F3 FM telephony.
- 1.5A2 Tone-modulated RATT, 60 wpm.
- 1.08F1 Single-channel RATT, 60 wpm.
- 1.24F1 Two-channel RATT, 100 wpm (2–30 mc).
- 2.85F1 Four-channel multiplex.
- 4F4 Facsimile.

#### TRANSMITTERS

The largest and most powerful transmitter used by the Navy (and the largest in the world) is the VLF installation on the Atlantic coast near the town of Cutler, Maine. Its 2 million-watt signal makes this transmitter the granddaddy of them all. Together with a similar station to be built in the Pacific area and the VLF station at Jim Creek, Washington State, the Navy is assured of reliable worldwide VLF coverage.

The smallest Navy transmitter is the handie-talkie, with an output of 0.027 watt that can be heard through a radius of a few miles. Most ships are equipped with transmitters rated at between 100 and 500 watts. It is difficult to generalize on the maximum range of shipboard equipment, for, as we learned in our study of wave propagation, the distance varies both daily and seasonally and is affected by atmospheric disturbances and geographical location. It may be said, however, that a ship rarely is out of radio communication because of equipment limitations.

In the VLF range there are no standard shipboard radio transmitters. The shore transmitters for this band are all of special design and are of tremendous size, with power ranging from 300 kw to 2 million watts.

The types of shipboard transmitters used in the LF through UHF bands are many and varied. Specific equipment models are treated later in this chapter following a discussion of the theory of operation of radio transmitters.

PURPOSE OF TRANSMITTER

The purpose of a radiotransmitter is to produce radiofrequency energy, and, with its amplifiers and antenna, to radiate a useful signal.

The general plan for all transmitters can be seen in figure 9-2.

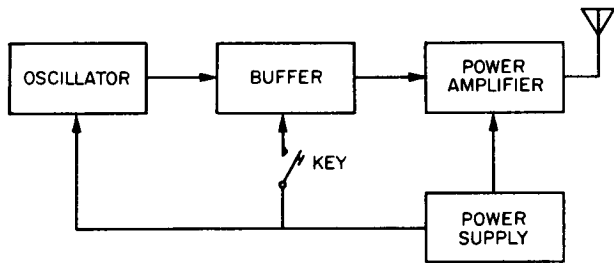

20. 201

Figure 9-2. —Stages of a typical transmitter.

Every transmitter has an oscillator that generates a steady flow of radiofrequency energy. The oscillator may be the self-excited type, which originates the signal in electron tubes and associated circuits. Or it may be of the crystal type, which uses, in conjunction with an electron tube, a quartz crystal cut to vibrate at a certain frequency when electrically energized. In either type, voltage and current delivered by the oscillator are very feeble, and both must be amplified many times to be radiated any distance.

The buffer stage is a voltage amplifier that increases the amplitude of the oscillator signal to a level that will drive the power amplifier. Voltage delivered by the buffer varies with the type of transmitter, but it may be hundreds or thousands of volts.

The buffer serves two other purposes, one of which is to isolate the oscillator from the amplifier stages. Without the buffer, changes in the amplifier due to keying or variations in source voltage would vary the load on the oscillator and cause it to change frequency. It may

also be a frequency multiplier, as we will see later.

The final stage of a transmitter is the power amplifier. Power is the product of current times voltage, and in the power amplifier a large amount of r-f current is made available for radiation by the antenna.

The power amplifier of a high-power transmitter may require far more driving power than can be supplied by an oscillator and its buffer stage. One or more low-power intermediate amplifiers may be required between the buffer and the final amplifier that feeds the antenna. The main difference between many low- and high-power transmitters is in the number of intermediate power-amplifying stages that are used.

In the block diagram of figure 9-3, the input and output powers are given for each stage of a typical medium-frequency transmitter. It is shown that the power output of a transmitter can be increased by adding amplifier stages capable of delivering the power required.

HARMONICS AND FREQUENCY MULTIPLICATION

The term harmonics is sometimes loosely used to designate unwanted radiations caused by imperfections in the transmitting equipment, but this is not entirely accurate. True harmonics are always exact multiples of the basic or fundamental frequency generated by the oscillator, and are created in the vacuum tubes and their associated circuits. Even harmonics are two, four, six, eight, etc., times the fundamental; odd harmonics are three, five, seven, nine, etc., times the fundamental. If an oscillator has a fundamental frequency of 2500 kc, harmonically related frequencies are—

- 5000 . . . . . 2d harmonic
- 7500 . . . . . 3d harmonic
- 10,000 . . . . . 4th harmonic
- 12,500 . . . . . 5th harmonic

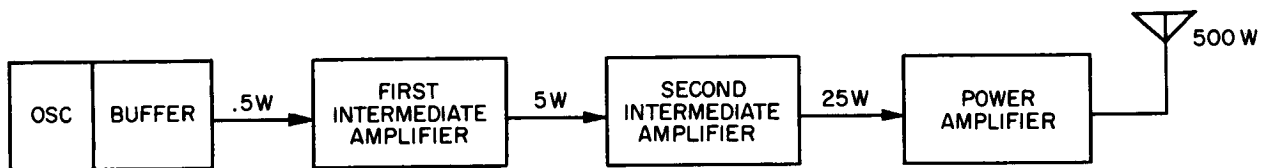

76. 15

Figure 9-3. —Intermediate amplifiers increase transmitter power.

The series ascends indefinitely until the intensity is too weak to be detected. In general, the energy in frequencies above the third harmonic is too weak to be significant.

It is difficult to design and build a stable oscillator for high frequencies; and, if a crystal is used to control a high-frequency oscillator, it must be ground so thin that it might crack while vibrating. These transmitters therefore have oscillators operating at comparatively low frequencies, sometimes as low as one-hundredth of the output frequency. The oscillator frequency is raised to the required output frequency by passing it through one or more frequency multipliers. Frequency multipliers are special power amplifiers that multiply the input fre-

the CARRIER, and information to be transmitted is added to it. The process of adding or superimposing information on the carrier is called MODULATION.

Modulation is accomplished by combining another (modulating) signal with the carrier. This is done in such a manner as to cause the output to vary in frequency or in amplitude according to the current or voltage variations of the modulating signal. The modulating signal usually is of a lower frequency than the carrier.

#### AMPLITUDE MODULATION

If the modulating frequency is impressed on the r-f output to vary its amplitude, it is called amplitude modulation (abbreviated a-m).

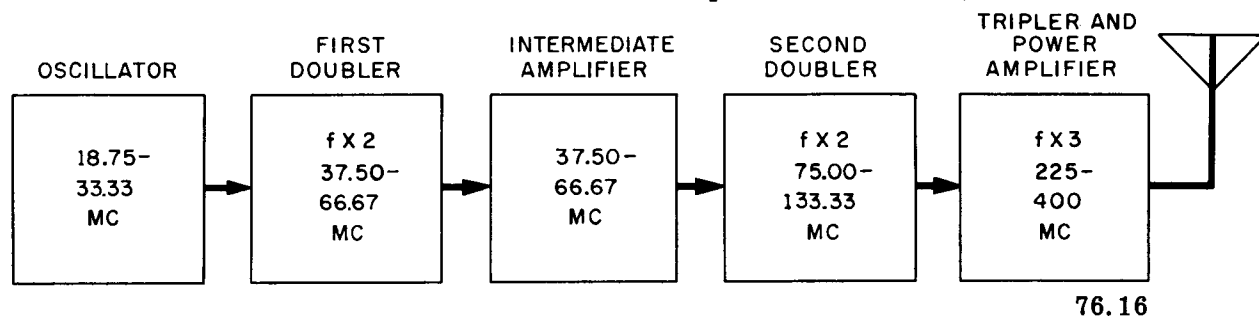

Figure 9-4. — Frequency-multiplying stages of typical VHF/UHF transmitter.

quency. The stages that multiply the frequency by two are called doublers; those that multiply by three are triplers; and those multiplying by four are quadruplers.

The main difference between many low-frequency and high-frequency transmitters is in the number of frequency-multiplying stages used. Figure 9-4 shows the block diagram of a typical Navy VHF/UHF transmitter. The oscillator in this transmitter is tunable from 18.75 mc to 33.33 mc. The multiplier stages increase the frequency by a factor of 12 by multiplying successively by 2, 2, and 3.

In high-power, high-frequency transmitters, one or more intermediate amplifiers may be used between the last frequency multiplier and the final power amplifier.

#### TRANSMISSION OF INFORMATION BY RADIO

Because the high-frequency output from the radiofrequency (r-f) section of a transmitter is constant in frequency and amplitude, it does not convey any intelligence by itself. This output is called the CARRIER WAVE, or simply

Figure 9-5 is a block diagram of an a-m radiotelephone transmitter, showing the waveforms for the various stages. The top row of blocks indicates the r-f section. The next row of blocks shows the a-f section; and the lower block points out the power supply, which provides all d-c voltages to the transmitter.

The r-f section (explained previously) generates the high-frequency carrier radiated by the antenna.

The audiofrequency (a-f) section includes a speech amplifier that receives considerably less than 1 volt of a-f signal from the microphone and builds it up to several volts at the input to the driver stage. The driver stage is made up of power amplifiers that convert the signal into a relatively large voltage and appreciable current at the input to the modulator. The modulation transformer is capable of handling considerable audio power. Its output is fed to the final r-f power amplifier in such a way as to alternately add to and subtract from the plate voltage of the power amplifier.

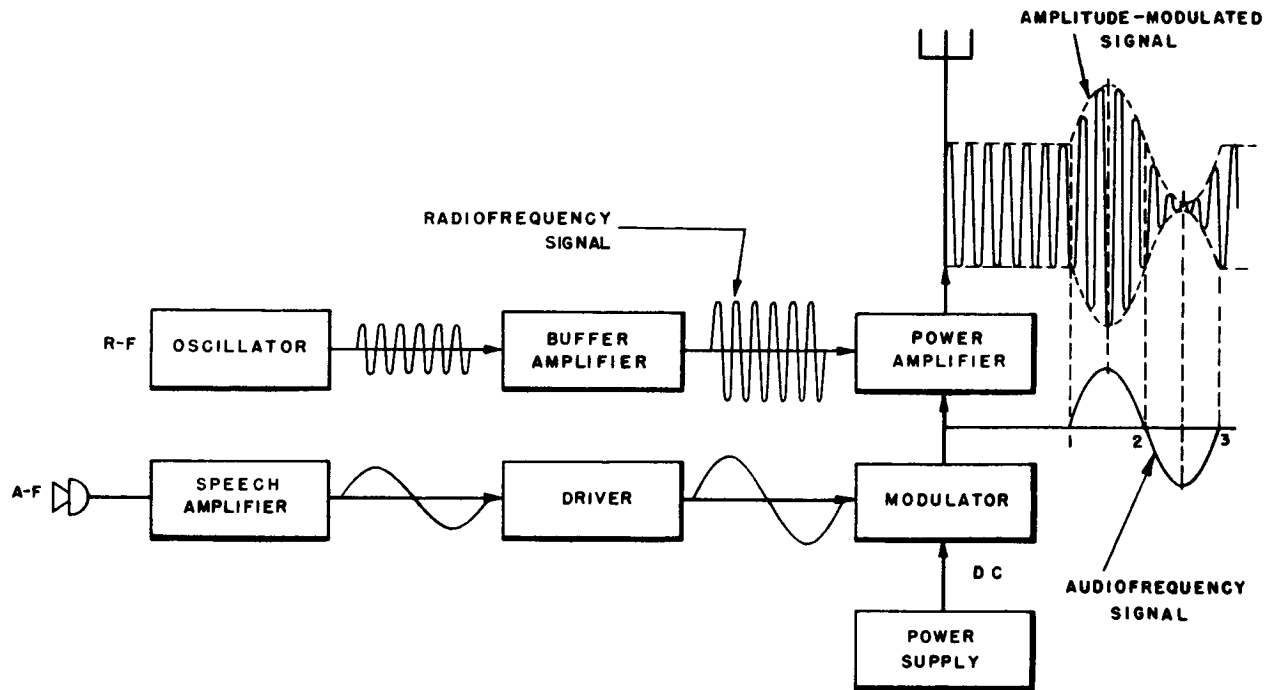

13. 53

Figure 9-5. —An a-m radiotelephone transmitter.

The result of the modulation is that the amplitude of the r-f field at the antenna is increased gradually during the time the a-f output is increasing the r-f power and decreased gradually during the time the a-f output is decreasing the r-f power.

In other words, during the positive alternation of the audio signal (between point 1 and point 2 in figure 9-5), the amplitude of the r-f output wave is increased, and during the negative alternation (between point 2 and point 3) it is decreased. Amplitude modulation consists of varying the amplitude of the r-f antenna current (and r-f output wave) gradually over the relatively long a-f cycle. Thus, the r-f field strength is alternately increased and decreased in accordance with the a-f signal and at the a-f rate.

Modulation may be accomplished by several methods, but the two most important to you are plate modulation and grid modulation. When modulation takes place in the plate circuit of the power amplifier it is said to be **HIGH-LEVEL MODULATION**. If the modulation is injected at the grid of the power amplifier (or at any point of lower voltage than the plate of the power amplifier, regardless of the stage) it is called **LOW-LEVEL MODULATION**. High-

level modulation is more efficient, but low-level modulation requires less power. Navy transmitters employ high-level modulation except in single-sideband transmitters where the high plate voltages make it impractical, and when weight is an important consideration, as it is in aircraft and portable equipment.

#### FREQUENCY MODULATION AND PHASE MODULATION

Besides its amplitude, the carrier wave has two other characteristics that can be varied to produce an intelligence-carrying signal. These are its frequency and its phase. The process of varying the frequency in accordance with the audiofrequencies of voice or music is called frequency modulation (f-m), and the process of varying the phase is phase modulation (p-m). These two types of modulation are closely related. When f-m is used, the phase of the carrier wave is indirectly affected. Similarly, when p-m is used, the carrier frequency is affected.

The primary advantages of f-m are improved fidelity and increased freedom from static. Because of these qualities, it is of considerable use in commercial broadcasting, but its short-



comings—frequency extravagance, short range on available frequencies, and others—have severely limited its naval communication applications. The Navy has, however, found f-m satisfactory for other purposes, among them altimeters and some radars.

### CONTINUOUS-WAVE TRANSMISSION

Radiotelegraph information can be transmitted by starting and stopping the carrier by means of a telegraph key that is opened and closed to control power output from the transmitter. Messages are sent by means of short and long pulses (dits and dahs); they correspond to letters and numerals of the Morse code. Thus, in CW telegraphy the carrier is merely turned on and off and is not changed in either frequency or amplitude.

### MODULATED CW TRANSMITTERS

Many Navy transmitters are designed for both CW radiotelegraph and a-m radiotelephone transmission.

Another mode of operation provided by many medium- and high-frequency transmitters and nearly all VHF-UHF equipments is modulated continuous-wave (MCW) telegraph transmission.

An MCW transmitter has an audiofrequency oscillator, generating a note of constant frequency used to modulate the r-f carrier. The received sound is at the frequency of the audio oscillator. The MCW telegraphy has a slightly greater distance range than voice modulation for the same transmitter. The range of MCW is always less, however, than that of CW transmission of the same transmitter.

Because of its limited range and its wide bandwidth (explained in the next topic), MCW has little application in Navy communications today. It is used so seldom that the newer transmitters do not even provide for this mode of operation. Instead, other modes of operation, such as frequency-shift keying for radioteletypewriter, are incorporated into the newer transmitters. (Frequency-shift keying is discussed in chapter 10.)

### SIDEBANDS AND BANDWIDTH

When an r-f carrier is modulated by a single audio note, two additional frequencies are produced. One is the upper frequency, which

equals the sum of the frequency of the carrier and the frequency of the audio note. The other frequency is the lower one, which equals the difference between the frequencies of the carrier and the audio note. The one higher than the carrier frequency is the UPPER SIDE FREQUENCY; the one lower than the carrier frequency is the LOWER SIDE FREQUENCY. When the modulating signal is made up of complex tones, as in speech or music, each individual frequency component of the modulating signal produces its own upper and lower side frequencies. These side frequencies occupy a band of frequencies lying between the carrier frequency, plus and minus the lowest modulating frequency, and the carrier frequency plus and minus the highest modulating frequency. The bands of frequencies containing the side frequencies are called SIDEBANDS. The sideband that includes the sum of the carrier and the modulating frequencies is known as the UPPER SIDEBAND (USB). The band containing the difference of the carrier and the modulating frequencies is known as the LOWER SIDEBAND (LSB). The space a carrier and its associated sidebands occupy in a frequency spectrum is called a channel. The width of the channel (called BANDWIDTH) is equal to twice the highest modulating frequency. For example, if a 5000-kc carrier is modulated by a band of frequencies ranging from 200 to 5000 cycles (0.2 to 5 kc), the upper sideband extends from 5000.2 to 5005 kc, and the lower sideband extends from 4999.8 to 4995 kc. The bandwidth is then 4995 to 5005, or 10 kc. The bandwidth is twice the value of the highest modulating frequency, which is 5 kc. This is illustrated in figure 9-6.

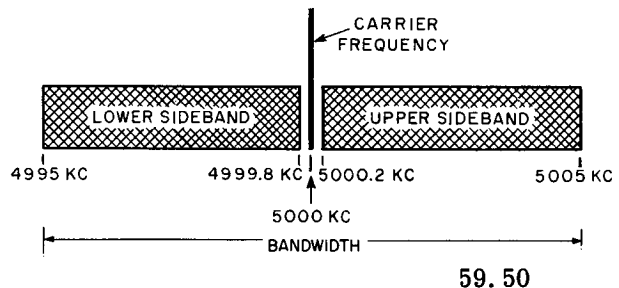

Figure 9-6.—Sidebands produced by amplitude modulation.

### SINGLE SIDEBAND

A mode of radio emission that has become increasingly important to the Radioman is sin-

gle sideband (SSB). Single sideband is not a new term in the history of communications. It has been used extensively by the shore communication system for many years. The congestion in the medium- and high-frequency bands and recent developments that have reduced the physical sizes of equipments have given a new impetus to the advantages of using SSB in fleet communications.

Following is a brief introduction to the technique of SSB.

In our study of sidebands, we learned that modulation of the carrier produces a complex signal consisting of three individual waves: the original carrier, plus two identical sidebands, each carrying the same intelligence. Naturally, this appears to be an uneconomical means of transmission. By eliminating the carrier and one of the sidebands, the same intelligence can be transmitted at a saving in power and frequency bandwidth.

### Suppressed Carrier

In SSB, the carrier itself is suppressed (or eliminated) at the transmitter, so that sideband frequencies are produced but the carrier is reduced to a minimum. This is usually the most difficult or troublesome aspect in understanding SSB suppressed carrier. In single sideband suppressed carrier, there is no carrier present in the transmitted signal. It is eliminated after modulation is accomplished, and reinserted at the receiver for the demodulation process. All the radiofrequency energy appearing at the transmitter output is concentrated in the sideband energy or "talk power."

After eliminating the carrier, the upper and lower sidebands remain. If, however, one of the two sidebands is filtered out before it reaches the power amplifier stage of the transmitter, the same intelligence can be transmitted on the remaining sideband. All the power is then transmitted in one sideband, instead of being divided between the carrier and both sidebands as in conventional a-m. This amounts to an increase in power for the wanted sideband. Equally important, the bandwidth required for SSB voice circuits is approximately half that needed for conventional a-m. (See fig. 9-7.)

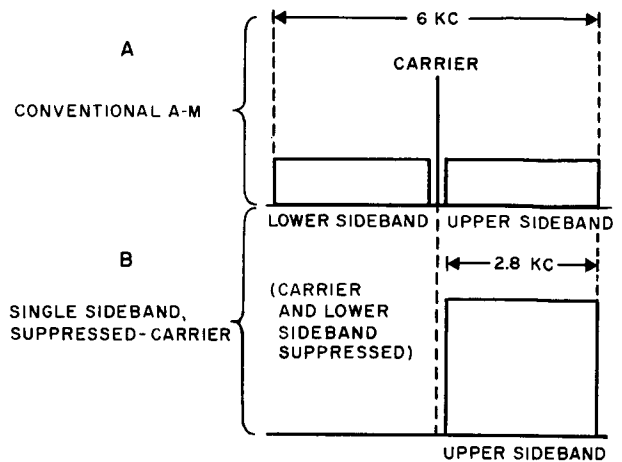

59.51

Figure 9-7. --Comparison of bandwidths of conventional a-m and SSB voice channels.

### SSB Advantages

The advantages of single sideband over conventional amplitude modulation are numerous, but only a few of the main ones are presented in the following paragraphs.

**MINIMIZATION OF DISTORTION.**—In conventional a-m, the two sidebands and the carrier must arrive at the receiver with the same phase relationship as they had when transmitted. If they are not received in phase (usually because of multipath skywave propagation conditions), the signal heard is fuzzy, distorted, and possibly quite loud. (You may have heard the report "Loud but distorted.") This occurs because one sideband experiences a slight phase shift and cancels a portion of the other sideband, resulting in distortion and loss of intelligibility. Fading or slight phase shift of the carrier can produce similar results. With the suppressed-carrier type of SSB, however, these problems are minimized because only one sideband and no carrier is transmitted.

**INCREASED EFFECTIVE POWER.**—In a conventional a-m system, approximately one-half of the transmitter's power goes into the carrier, and the remaining one-half is divided equally between the two sidebands. With the suppressed-carrier SSB system, virtually all of the transmitter's power goes into the single sideband that carries the useful intelligence. This more efficient utilization of power gives the SSB voice circuit a much greater distance range than that of a normal a-m voice circuit.

**PROVISION FOR DOUBLE THE NUMBER OF CHANNELS.**—In the system of SSB suppressed carrier, the number of voice channels utilizing the same frequency in the radio spectrum is doubled. These two channels are referred to as the upper and lower sidebands. With the scarcity of frequencies available for new assignments in the spectrum, particularly in the 2- to 30-mc range, this is an important advantage in fleet communications.

**REDUCTION OF INTERFERENCE.**—In voice systems employing conventional amplitude modulation, the carrier of the transmitting station remains on the air as long as the microphone button is depressed. If an additional station transmits while the carrier of the other station is on, squeals and howls result. They are caused by the heterodyning of two or more signals transmitting at the same time. In SSB, as soon as the individual stops speaking into the microphone, talk power in the remaining, or single, sideband leaves the air. Even though two stations may transmit at the same time, it may be possible for a receiving station to read through the interfering station the same way we are able to listen to more than one conversation at the same time around the mess table.

#### REPRESENTATIVE TRANSMITTERS

Modern medium-frequency and high-frequency shipboard transmitters must be capable of transmitting over a wide range of frequencies. In addition to CW and radiotelephone modes of operation, they must be used also for SSB, RATT, and FAX transmissions. They must be of rugged construction for long service life. Transmitters that meet these requirements are quite complex, and, because of the limited space available for radio installations in naval vessels, are of compact construction.

One method of obtaining equipment compactness is to combine a transmitter and a receiver into one unit called a transceiver. A transceiver uses part of the same electronic circuitry for both transmitting and receiving, hence cannot transmit and receive simultaneously. A transmitter-receiver, however, is a separate transmitter and receiver mounted in the same rack or cabinet. The same antenna may be utilized for the transmitter-receiver arrangement, but the capability for independent operation of the equipment still exists. You will find both terms used in the equipment descriptions that follow.

#### RADIO SET AN/URC-32

Radio Set AN/URC-32 (fig. 9-8) is a manually operated radio communication transceiver for operation in the 2- to 30-mc (high-frequency) range, with a power output of 500 watts. This transmitter is designed for single-sideband transmission, and for reception on upper sideband, lower sideband, or the two independent sidebands simultaneously, with separate audio and intermediate frequency (i-f) channels for each sideband. In addition to single-sideband operation, provisions are included for compatible a-m (carrier plus upper sideband), CW, or fsk operation.

#### General Description

The frequency range of 2 to 30 mc is covered in four bands. The desired operating frequency is selected in 1 kc increments on a direct-reading frequency counter. Frequency accuracy and stability are controlled by a self-contained frequency standard. Provisions also are made for using an external frequency standard.

During transmission (fig. 9-9) voice input signals from the handset are fed to the handset adapter. Input signals (CW or remote audio) from a remote control unit (when used) are also applied to the handset adapter input terminals. A local-remote switch permits the operator to select either the local audio input from the handset adapter or the remote audio input. Teletypewriter signals (analyzed in chapter 10) are applied directly to the CW and fsk unit which provides separate audio tones for the mark and space conditions. These audio frequencies are converted later to the required frequency-shift signals for the fsk transmission.

The output from the handset adapter is amplified in the audio and control unit. Two separate audio input paths to the audio and control unit are provided through the 600-ohm remote audio lines.

The audio and control unit amplifies the audio signals and feeds it to the sideband generator. During single-sideband voice operation (using the upper sideband), the audio and control unit output is fed through a selector switch in the CW and fsk unit. Lower sideband transmit signals are fed directly to the sideband generator. During CW or fsk operation,

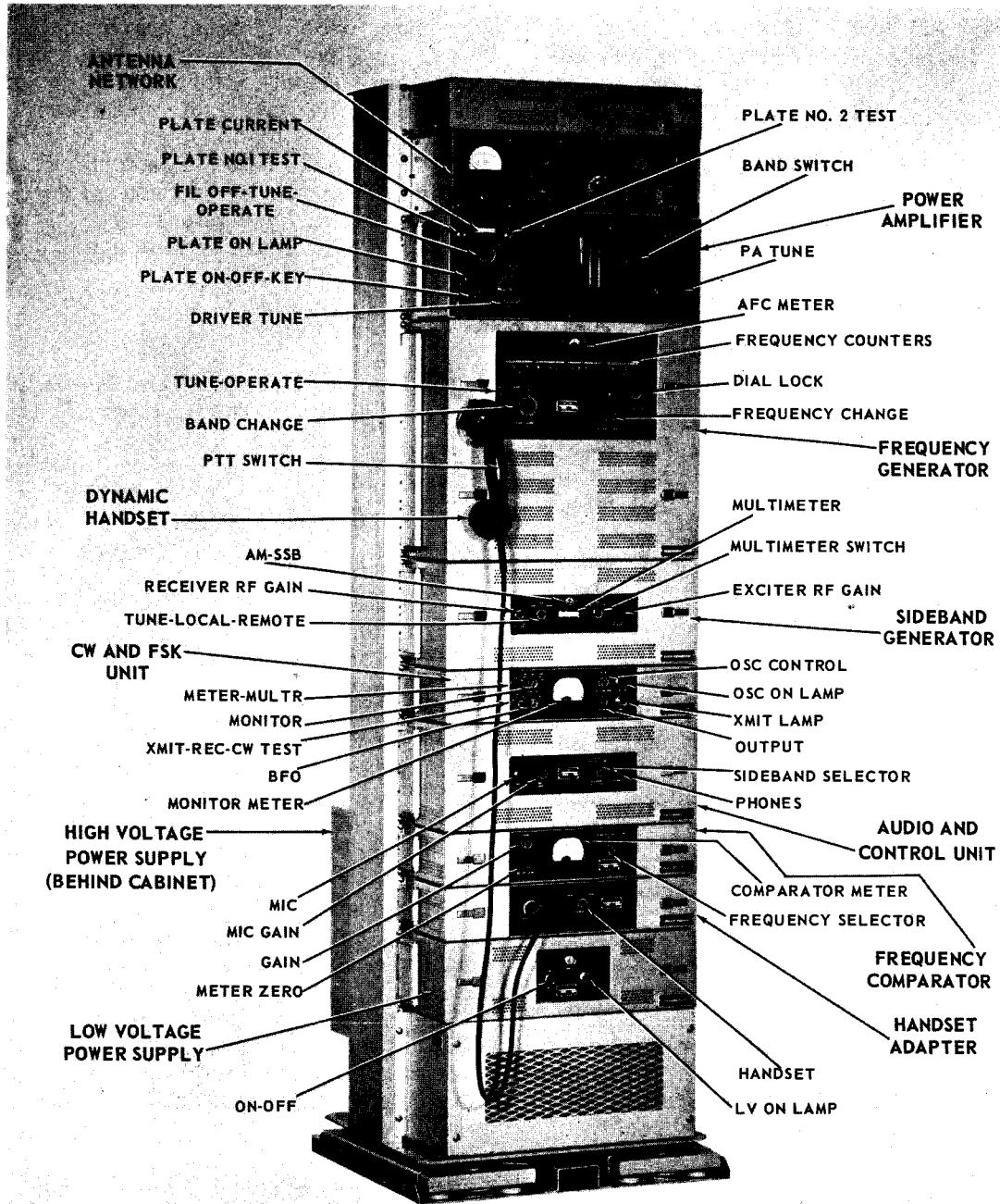
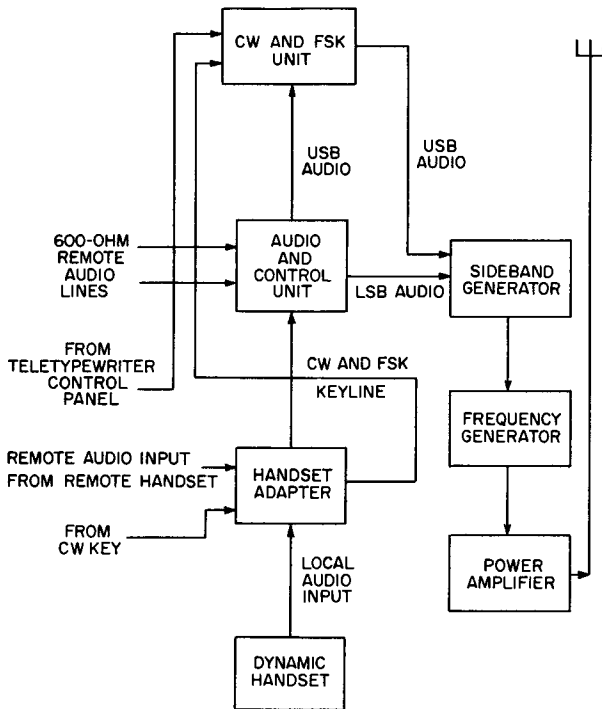

Figure 9-8. — Radio Set AN/URC-32, relationship of units and operating controls. 32. 135



32.136

Figure 9-9.—Radio Set AN/URC-32, transmit function block diagram.

the CW and fsk unit supplies audio tones to the sideband generator.

The sideband generator converts the audio input to 300 kc intermediate frequency on the selected sideband. The modulated 300-kc output is fed to the frequency generator. This unit provides the necessary number of heterodyning (mixing) processes (while preserving the signal intelligence) to produce the selected carrier frequency in the 2- to 30-mc range. The output signal is amplified in the power amplifier to the required output of 500 watts and fed to the antenna.

During the reception of modulated signals (receive operation), the antenna input signal (fig. 9-10) in the range from 2 to 30 mc is heterodyned in the frequency generator so that the output will be a modulated 300-kc signal. (When receiving SSB signals, the carrier is reinserted for demodulation purposes.) This signal is detected (demodulated) and amplified in the sideband generator, further amplified in the audio and control unit, and fed to the speaker.

During CW reception, the CW and fsk unit supplies a 300.550-kc signal to the sideband generator as a beat frequency for the received

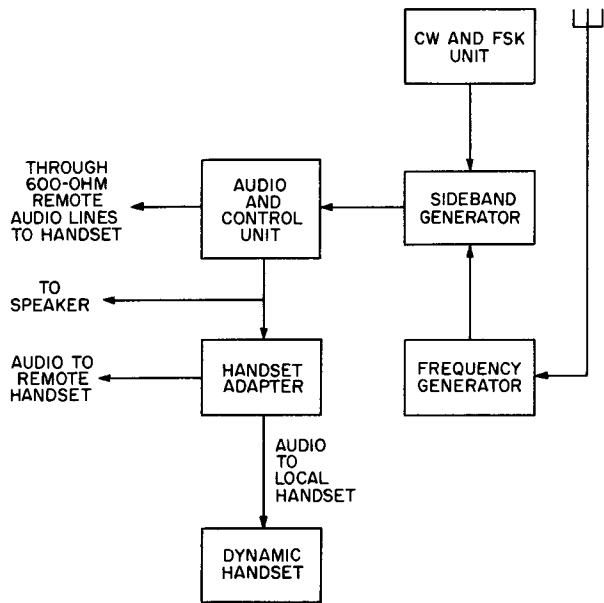

32.137

Figure 9-10.—Radio Set AN/URC-32, receive function block diagram.

signal. (A beat frequency is a locally generated r-f signal that is heterodyned with the carrier to produce an audiofrequency.) The beat frequency can be changed over a range of  $\pm 1$  kilocycle.

#### Operating Procedure

The following preliminary settings must be performed before turning on the equipment (refer to figure 9-8 for location of controls).

Low-voltage power . . . ON-OFF switch to OFF.  
supply

Power amplifier . . . FIL OFF-TUNE-OPERATE switch to FIL OFF.

PLATE switch to OFF.

Sideband generator. . . RECEIVER RF GAIN control counterclockwise.

EXCITER RF GAIN control counterclockwise.

TUNE-LOCAL-REMOTE switch to LOCAL.

Frequency com- . . FREQUENCY SELECTOR  
 parator switch to OFF.

CW and FSK unit . . XMIT-REC-XMIT TEST  
 switch to REC. OSC  
 CONTROL switch to  
 OFF.

Audio and control . . MIC GAIN control  
 unit counterclockwise.  
 SIDEBAND SELECTOR  
 switch to OFF.

lected frequency counter. The AN/URC-32 frequency bands are—

- Band 1 2.0 to 3.7 mc
- Band 2 3.7 to 7.7 mc
- Band 3 7.7 to 15.7 mc
- Band 4 15.7 to 30.0 mc

3. Release DIAL LOCK on the frequency generator. Set the desired operating frequency on the lighted frequency counter using the FREQUENCY CHANGE control. When selecting a frequency that is not on the band 7.7-15.6 mc, or 15.7- to 30.0-mc frequency counters, set the frequency counter to the next lower frequency on the counter and set the BAND CHANGE switch to ADD 1, ADD 2, or ADD 3. With the BAND CHANGE switch in the ADD 1 position, 1 kc is added to the frequency indicated on the frequency counter. In the ADD 2 position, 2 kcs are added, and in the ADD 3 position, 3 kcs are added. When the desired operating frequency is on the frequency counter, set the BAND CHANGE switch to ADD 0.

EXAMPLE: To select an operating frequency of 23.699 mc, set the BAND CHANGE switch to BAND 4, set the 15.7- to 30.0-mc frequency counter to 23.696 mc using the FREQUENCY CHANGE control, and reset the BAND CHANGE switch to BAND 4 ADD 3.

When setting up a frequency on any band, make certain the white index line on the last dial of the 15.7- to 30.0-mc frequency counter is centered in the window.

4. Reset DIAL LOCK and momentarily depress the TUNE-OPERATE switch on frequency generator to TUNE. This action prevents the stabilized master oscillator from locking on spurious signals. The AFC meter shows the amount of correction being supplied to the master oscillator from the stabilization circuits and should not be expected to read 0 unless the master oscillator is exactly on frequency and no correction is required.

5. Adjust RECEIVER RF GAIN control so that the automatic gain control (AGC) does not increase the gain excessively between characters in CW and FSK or between words in single-sideband voice reception. The RECEIVER RF GAIN control normally is set so that the sideband generator meter (AGC) "kicks up" about 15 db with the meter switch in the TGC-AGC position. If speaker, handset, or remote audio output level is inadequate, set SPEAKER GAIN control (under dust cover of audio and control unit) for desired output level. On FSK

**TURNING ON EQUIPMENT.**—The following procedure is used to apply power to the equipment. If the equipment is to be used only as a receiver, perform only steps 1 and 2.

1. Set OFF-ON switch on low-voltage power supply to the ON position. The indicator lamp on low-voltage power supply will light when air pressure is present in the cooling system.

2. Set the meter selector switch on sideband generator to the -90, +130, and +250 positions and check that the meter reads between 35 and 50 db in each position.

3. Turn the FIL OFF-TUNE-OPERATE switch on power amplifier to the OPERATE position. Wait 30 seconds before performing step 4.

4. Depress the PLATE switch on the power amplifier to KEY and check that PLATE CURRENT meter on power amplifier reads 150 ma of plate current. PLATE lamp on power amplifier HV ON lamp on high-voltage power supply, and XMIT lamp on CW and FSK unit should light while the switch is depressed.

5. Depress PLATE switch to KAY and alternately depress PLATE NO. 1 TEST switch and PL NO. 2 TEST switch on the power amplifier, checking that the PLATE CURRENT meter reads between 60 and 90 ma of plate current for each tube.

6. Operate PLATE switch on power amplifier to ON. PLATE LAMP on power amplifier and the HV ON lamp on high-voltage power supply should light.

**TUNING PROCEDURE.**—The tuning procedure for setting the AN/URC-32 to a new operating frequency is as follows:

1. Set PLATE switch on power amplifier to OFF.

2. Set BAND CHANGE switch on the frequency generator to the desired frequency band. The band indicator lamp will light over the se-

operation, adjust BFO control for proper operation of FSK converter. This action completes tuning of the receiver portion of the AN/URC-32.

Before performing the following steps, the AN/URC-32 must be connected to an antenna system containing an antenna tuner control and a dummy load, such as the AN/SRA-22. This type of antenna tuner contains a directional wattmeter and a switch for selecting the antenna or the dummy load.

6. Set the ANT-LOAD switch on the antenna tuner control to LOAD. Set the FIL OFF-TUNE-OPERATE switch on power amplifier to TUNE. Set the meter selector switch on the sideband generator to RF OUT. Set TUNE-LOCAL-REMOTE switch on the sideband generator to TUNE.

In the following steps, key to transmit by depressing the PLATE switch on the power amplifier to KEY.

7. With the EXCITER RF GAIN control in the maximum counterclockwise position, key to transmit and turn EXCITER RF GAIN control clockwise until meter on the sideband generator reads approximately 40 db.

8. Key to transmit and adjust DRIVER TUNE control on the power amplifier within the desired band limits to peak the PLATE CURRENT meter reading, and adjust the EXCITER RF GAIN control as necessary to maintain a PLATE CURRENT meter reading of approximately 200 milliamperes. The red index on the DRIVER TUNE control must fall within the proper band limits marked on the panel. If a power output reading is observed on the power output meter of the antenna tuner, detune the P. A. TUNE control until no power output is indicated. This effectively disables the r-f feedback so that optimum adjustment of the driver plate circuit can be obtained. Reducing EXCITER RF GAIN control for a decrease in PLATE CURRENT meter reading, as necessary, results in a sharper indication of driver tuning.

After completing step 8, make no further adjustments on the DRIVER TUNE control for the remainder of the tuning procedure.

9. Set the P. A. TUNE control on the power amplifier within the desired frequency band limits. Key to transmit and adjust P. A. TUNE control for a dip in the PLATE CURRENT meter reading.

10. Set EXCITER RF GAIN control maximum counterclockwise. Set FIL OFF-TUNE-

OPERATE switch on the power amplifier to OPERATE.

11. Key to transmit, turn EXCITER RF GAIN control clockwise until 500 watts of forward power is indicated and redip PLATE CURRENT meter reading using the P. A. TUNE control. The PLATE CURRENT meter reading should not exceed 500 milliamperes. DO NOT OPERATE ANT-LOAD SWITCH WHILE AN/URC-32 IS KEYED TO TRANSMIT.

12. Set ANT-LOAD switch on antenna tuner control to ANT and adjust antenna tuner controls for minimum reflected power. For this procedure see the operating procedures in the antenna tuner control technical manual.

13. Key to transmit and adjust EXCITER RF GAIN control for a forward power output meter reading of 500 watts. The reflected power meter reading should be less than 10 watts. The PLATE CURRENT meter reading should be between 450 and 550 milliamperes.

14. Key to transmit and adjust the EXCITER RF GAIN control for a forward power output of 125 watts.

15. Key to transmit and check the following meter readings:

PLATE CURRENT . Approx. 300 ma.  
meter  
Forward power . . . 125 watts.  
output  
Reflected power . . Less than 3 watts.  
Sideband gener- . . 10 to 20 db.  
ator meter  
RF OUT  
Sideband gener- . . 0 db.  
ator meter  
TGC

16. Set TUNE-LOCAL-REMOTE switch on the sideband generator to LOCAL. On AM transmit operation, readjust EXCITER RF GAIN control for 125 watts forward power. Set PLATE switch on the power amplifier to ON. This completes the tuning procedures.

#### AN/SRT-15 TRANSMITTER

The AN/SRT-15 (fig. 9-11) is one model of a series of radio transmitters. This transmitter replaced older equipments such as Navy models TAJ, TBL, TBK, and TBM. It is capable of performing the operations that heretofore have required several separate transmitters, and the space needed is considerably less than that of the older models.

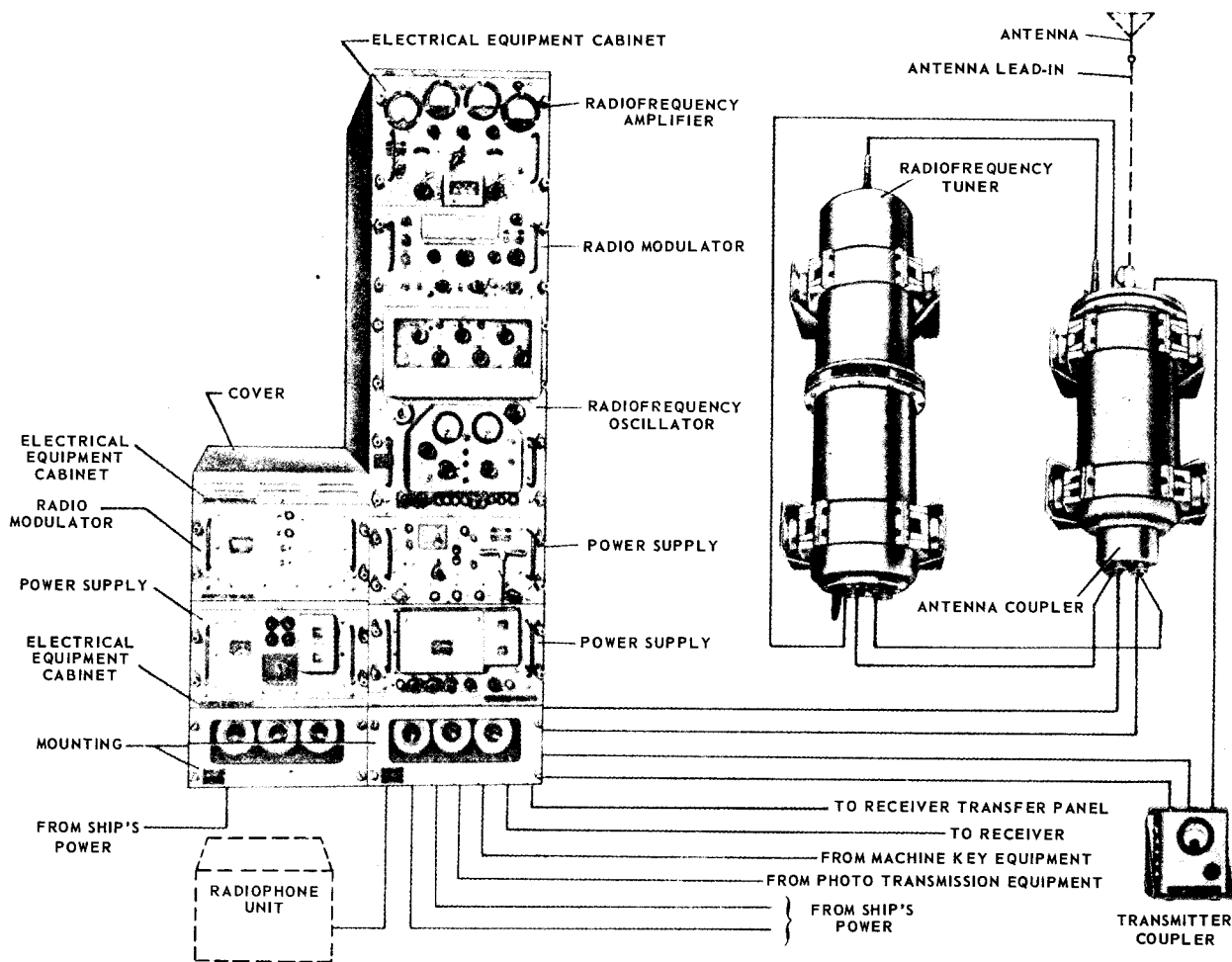

1. 144  
Figure 9-11. —Radio transmitter AN/SRT-15.

The three transmitters in the series are known as the AN/SRT-14, -15, and -16. The AN/SRT-14 is the basic transmitter, and has a power output of 100 watts. The AN/SRT-15 is the same, with the addition of a 500-watt booster amplifier and its associated power supply, thus providing optional output power of either 100 or 500 watts over the frequency range 2 to 26 mc; output is limited to 100 watts in the MF band from 0.3 to 2 mc. The AN/SRT-16 consists of two AN/SRT-14 equipments plus the booster amplifier, furnishing two entirely independent transmitting channels of 100-watt output, with the 500-watt booster amplifier available for use with either channel when desired.

All three transmitters cover the frequency range 0.3 to 26 mc, and may be used for CW,

radiotelephone, radioteletypewriter, and FAX transmissions.

#### AN/WRT-1

The AN/WRT-1 (fig. 9-12) is a modern MF transmitter installed in surface vessels. It covers the frequency range 300 to 1500 kc, with an output power of 500 watts, and can be used for CW, teletypewriter, and radiotelephone. This transmitter has a built-in dummy load for use in tuning the transmitter under radio silence conditions.

#### AN/WRT-2

The AN/WRT-2 is a modern HF transmitter used in surface ships and submarines. It cov-



ers the range of 2 to 30 mc in 12 frequency bands. The r-f oscillator produces fundamental frequencies from 2 to 8 mc; frequency multiplication is used to produce frequencies from 8 to 30 mc.

The AN/WRT-2 transmitter has an output power of 500 watts on CW, frequency-shift RATT and FAX, and conventional AM radiotelephone. It has an output power of 1000 watts when transmitting single sideband. It may also be used for transmitting separate intelligence on each independent sideband. A built-in dummy load permits off-the-air tuning under radio silence conditions.

The AN/WRT-2 (not illustrated) is similar in size and constructional appearance to model AN/WRT-1 (fig. 9-12).

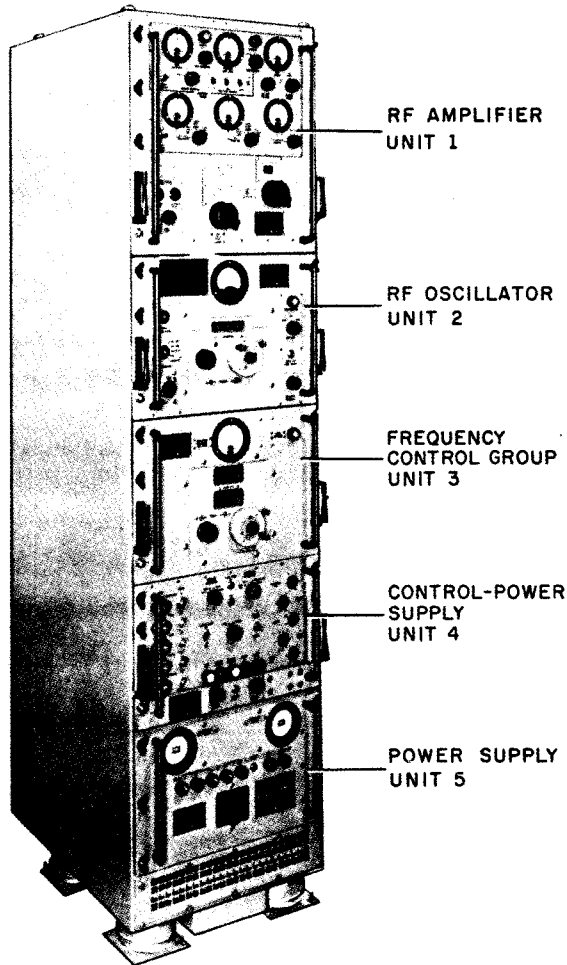

32. 278(76)  
Figure 9-12. —AN/WRT-1 transmitter.

### AN/URT-17

The AN/URT-17 transmitter (fig. 9-13), with its extended range and higher power, has many features not found in the older transmitters. It can be used for radiotelephone, CW, RATT, and FAX operation on all frequencies from 2 to 32 mc. It provides output power of 1000 watts for CW or RATT, and 750 watts for radiotelephone. The most outstanding feature is its SSB capabilities. The SSB exciter provides choices of single sideband with suppressed carrier, two independent sidebands with suppressed carrier, double sideband with full carrier, or CW operation. It presently is installed in major flagships and headquarters of fleet commanders.

### AN/URC-7

The AN/URC-7 is an amplitude-modulated radiotelephone transmitter-receiver for short- and medium-distance radiotelephone communication. Both transmitter and receiver have six

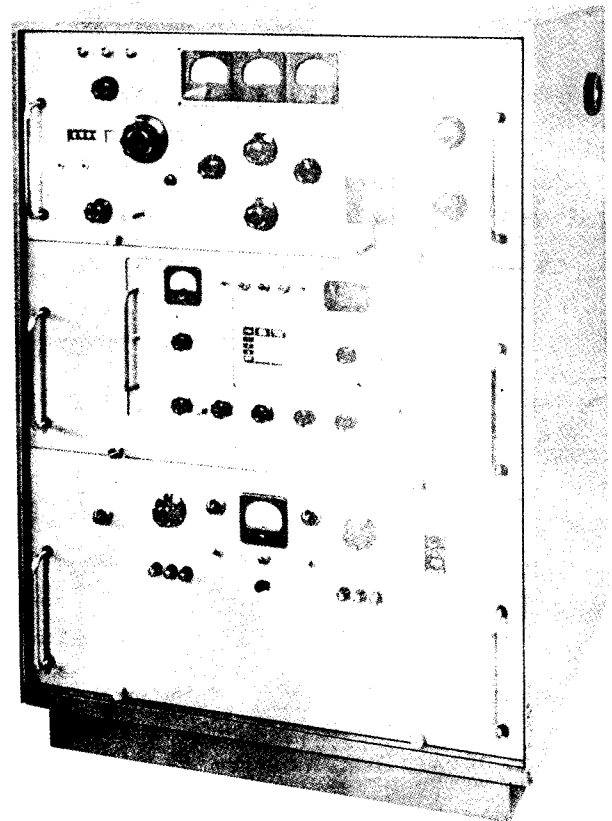

76. 18  
Figure 9-13. —AN/URT-17 transmitter.

pretuned crystal - controlled channels in the frequency range 2000 to 7000 kc. The transmitter has an output power of 25 watts. The transmitter, receiver, and modulator power supply are contained in a single cabinet (fig. 9-14).

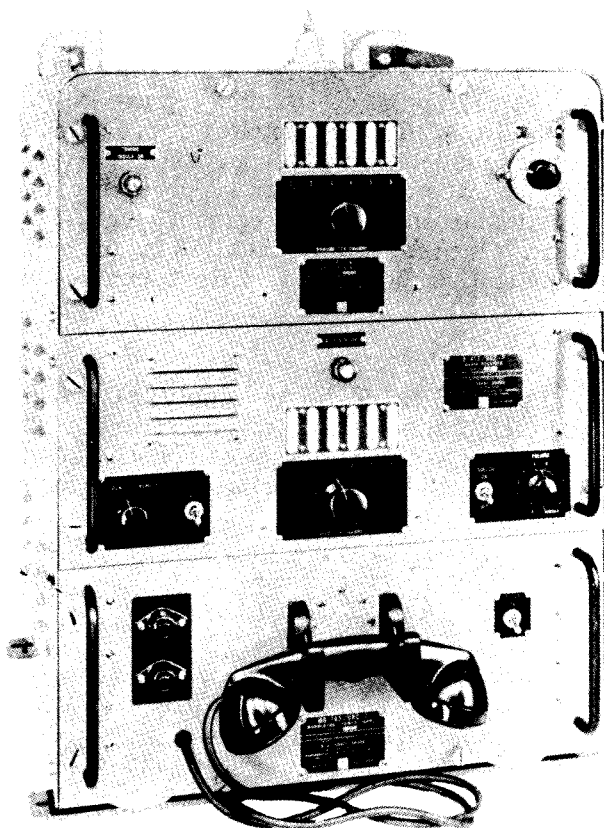

76.19

Figure 9-14. —AN/URC-7 transmitter.

The AN/URC-7 is used principally in service craft and auxiliary-type ships, such as tugs, transports, tankers, and ships of the amphibious force.

#### AN/WRC-1

Radio Set AN/WRC-1 (fig. 9-15) is a transmitter-receiver that covers the frequency range of 2 to 30 megacycles in 1-kilocycle steps. It has a power output of 100 watts, and is capable of transmission and reception on upper sideband, lower sideband, continuous wave, amplitude modulation, frequency shift keying, and independent sideband modes of operation.

The independent sideband mode of operation allows the transmission and reception of different information on USB and LSB simultaneously.

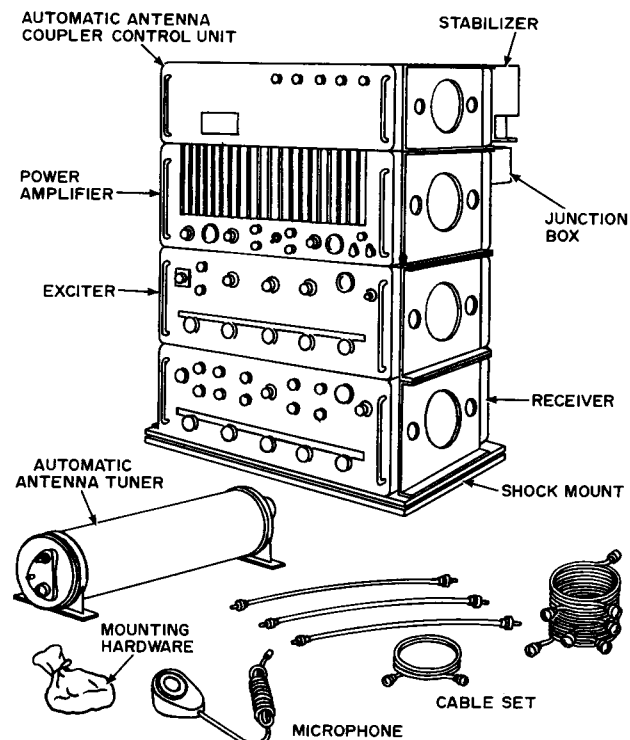

76.20

Figure 9-15. —Radio Set AN/WRC-1.

#### TBL

The TBL transmitter (fig. 9-16) is a low-power equipment used extensively for many years. It operates in two frequency ranges and has an output of 200 watts on CW and 100 watts on MCW. The low-frequency side covers the range 175 to 600 kc, and the high side from 2 to 18 mc. This means that the TBL can be used to cover two frequency ranges, resulting in important space saving. Both sides of this transmitter cannot be keyed simultaneously; however, to shift from one frequency range to the other is merely a matter of throwing a switch. This transmitter requires a separate speech amplifier (not illustrated) when used for voice transmission. The most recent improvement to the TBL is field change AN/WRA-1, which permits use of this transmitter for single-sideband operation.

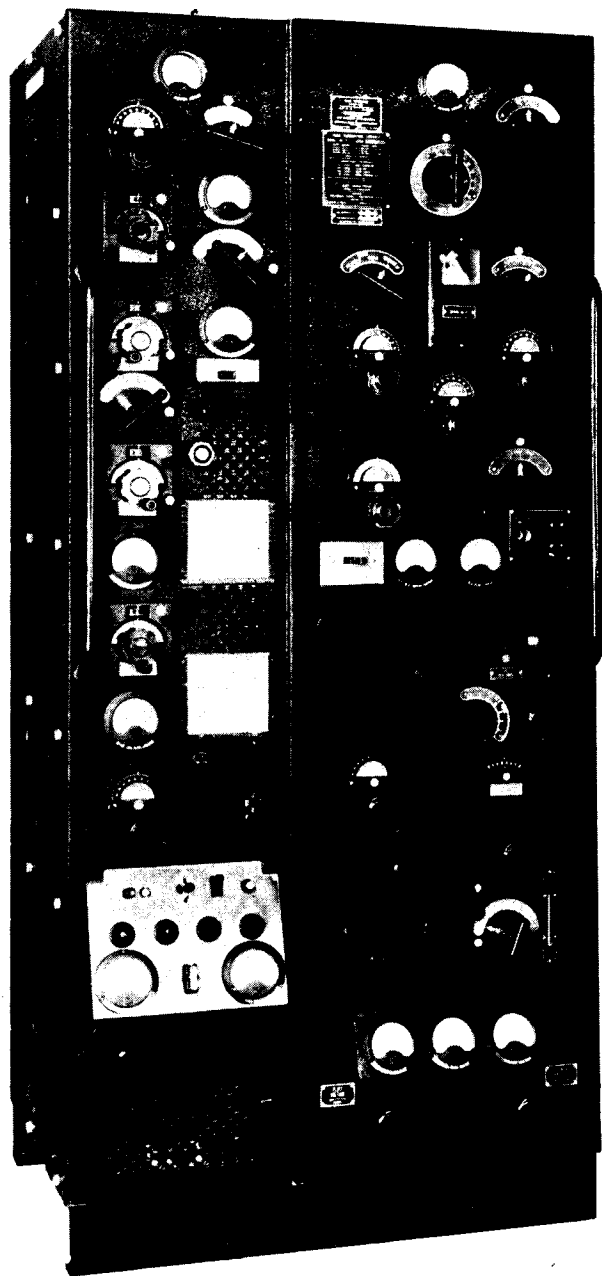

76.21  
Figure 9-16. — TBL transmitter.

#### TCS

The model TCS (fig. 9-17) is a small transmitter-receiver that has been in use for many years for short-range voice communications. It has an output power of 10 watts for radiotelephone and 25 watts for CW. The TCS has a frequency range of 1.5 to 12 mc. The fre-

quency-determining section may be either crystal-controlled or a continuously variable oscillator, whichever is more desirable. Transmitter and receiver use the same antenna, which is switched from receiver to transmitter by a relay when the transmitter is keyed. A 20-foot vertical whip antenna is most commonly used. This TCS still is used aboard many ships, and also in motorboats, trucks, and other mobile and portable installations.

#### VHF TRANSMITTERS

Equipments in the VHF range are not used extensively any more, because no primary naval communications are conducted in this range. Most tactical voice circuits now use the UHF band. Limited installations of VHF equipment are retained for communication with allied forces who have not yet converted to UHF equipments. Two VHF transmitters still in use are described here.

#### AN/URT-7

The AN/URT-7 is a crystal-controlled radiotelephone and MCW transmitter in the frequency range 115 to 156 mc. It has an output power of 30 watts and is used for short-range communications by surface ships, submarines, and shore stations. This transmitter (not illustrated) is similar in size and appearance to model TED UHF equipment (fig. 9-19).

#### TDQ

The TDQ transmitter (fig. 9-18) operates radiotelephone and MCW in the frequency range 115 to 156 mc. It is crystal-controlled and has a 45-watt power output. This transmitter is being replaced by AN/URT-7.

#### UHF TRANSMITTERS

The UHF transmitters are used throughout the Navy. They operate in the 225- to 400-mc frequency range, and their primary uses are for tactical surface and air radiotelephone communications.

Power output requirements are relatively low because the effective range of UHF is normally limited to line-of-sight distances. Although UHF transmitters are designed also for MCW emission, radiotelephone is most commonly used.

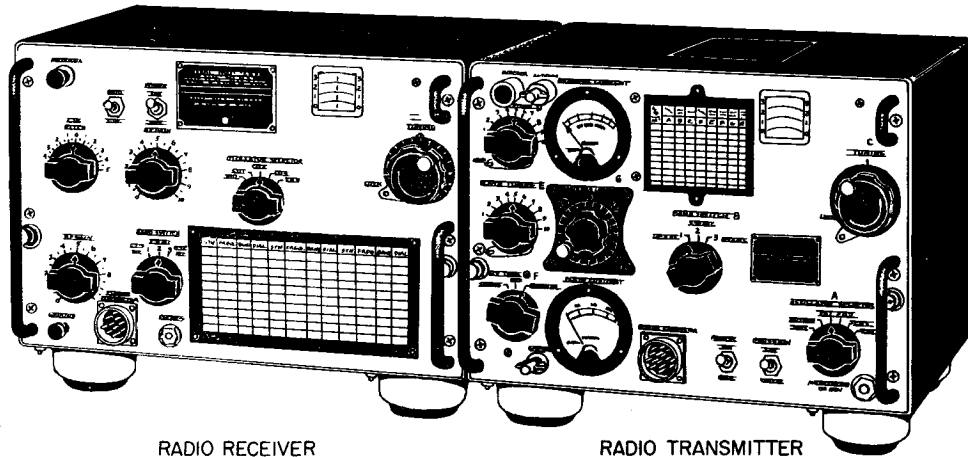

RADIO RECEIVER

RADIO TRANSMITTER

76.22

Figure 9-17. — TCS transmitter-receiver.

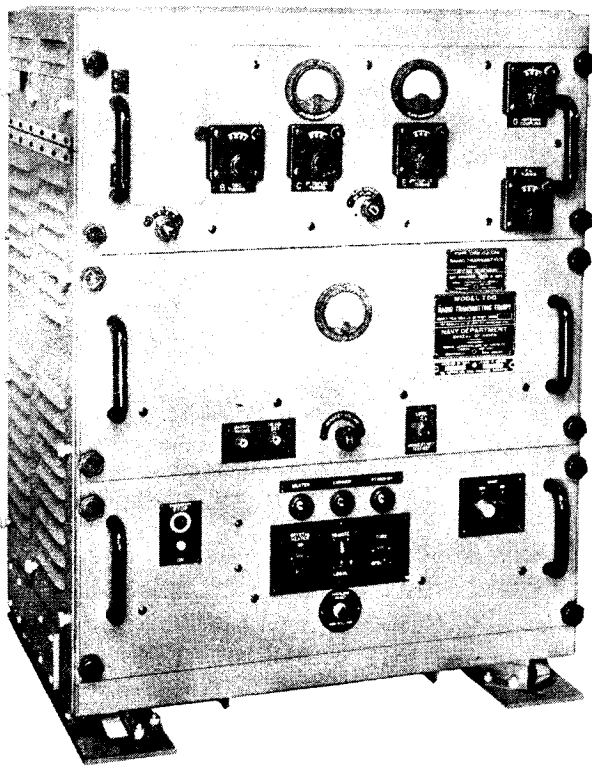

50.71

Figure 9-18. — TDQ transmitter.

## NAVY MODEL TED

The TED (fig. 9-19) is a crystal-controlled, single-channel, short-range, UHF transmitter

for use primarily in ship-to-ship, ship-to-air - craft, and harbor communications. Its frequency range is from 225 to 400 mc. It is installed in surface ships, submarines, and shore stations.

Although mountings for four crystals are provided, permitting rapid selection of any one of four frequencies, the transmitter must be retuned each time the frequency is changed.

The TED transmitter has an output power of 15 watts. An r-f amplifier, AM-1365/URT, is designed for use with the TED transmitter, and currently is being installed in the fleet. This amplifier boosts the output power to 100 watts.

## AN/GRC-27

The AN/GRC-27 and AN/GRC-27A are UHF transmitter-receiver sets covering frequencies from 225 to 400 mc. The AN/GRC-27A, the shipboard installation, is shown in figure 9-20. This equipment is used for UHF radio telephone and MCW communications from ship-to-ship, ship-to-shore, or with aircraft. It can be used in net operation with other radio sets in the UHF band, such as the TED transmitter and AN/URR-13 and 35 receivers.

The transmitters has a power output of 100 watts. It has three crystal-controlled oscillators, using a total of 38 crystals. These crystals are located within the transmitter and do not require handling by the operator. From the combination and multiplication of these 38 crystal frequencies are produced 1750 frequencies spaced at 100-kc intervals throughout the

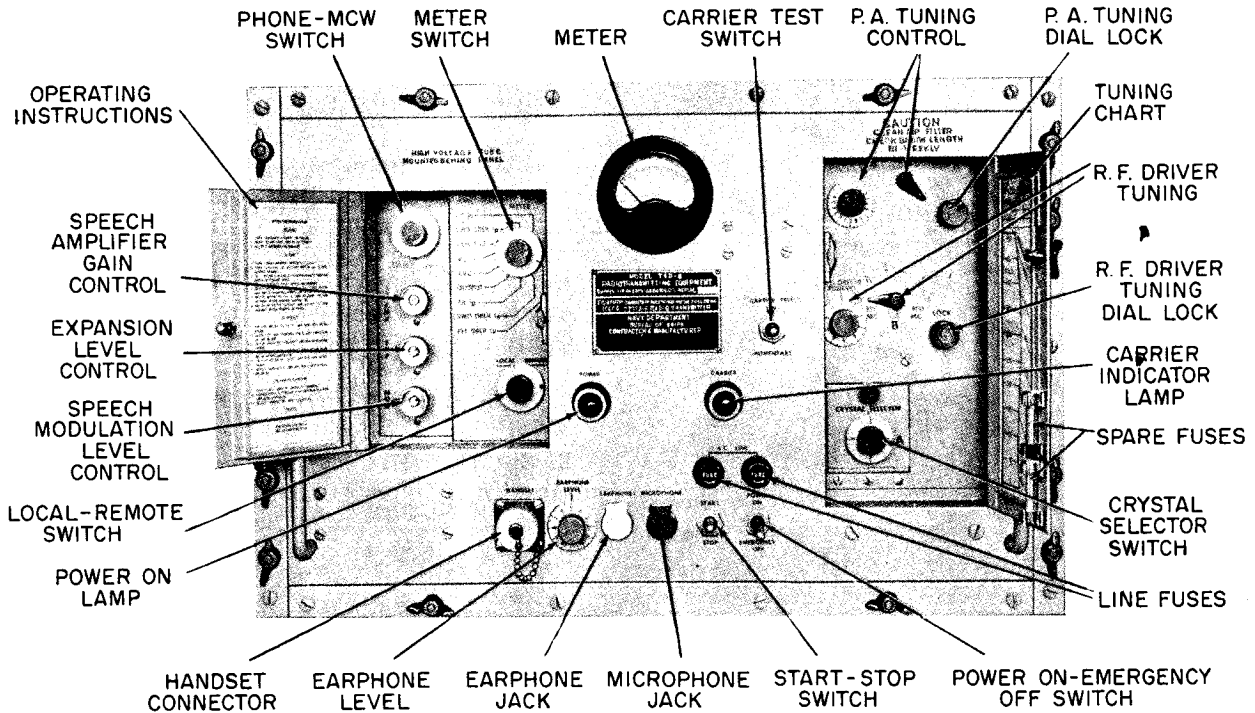

32.38

Figure 9-19. — UHF radio transmitter, model TED.

transmitter's frequency range. Any 10 of these 1750 frequencies can be preset manually with selector switch dials. Any one of the 10 preset frequencies can then be selected automatically by a telephone-type dial, either locally at the transmitter, or from a remote unit at other locations, such as CIC and the bridge. It takes only 2 to 7 seconds to shift automatically from one channel to another in any of the 10 preset channels.

Both transmitter and receiver use the same antenna. A relay switches the antenna from one to the other.

The receiver also operates on any of the 1750 channels. It is a triple-conversion superheterodyne and has crystal oscillators using 38 crystals in a system separate from but similar to that used in the transmitter. Here, again, automatic shifting of channels is done in about 2 to 7 seconds. The receiver has AVC (automatic volume control), automatic noise limiter, and a squelch circuit.

The AN/GRC-27A is installed principally in carriers and radar picket vessels, whose primary missions involve the control of aircraft.

## RECEIVERS

Receivers perform the function of intercepting a tiny part of the radio wave radiated by transmitters and of recovering the information contained in it.

### FUNCTIONS OF RECEIVERS

Radio receivers must perform the following six functions (fig. 9-21):

1. Signal interception.
2. Signal selection.
3. Radiofrequency amplification.
4. Detection.
5. Audiofrequency amplification.
6. Sound reproduction

These six functions are sufficient for a-m reception, but for CW reception an additional circuit (shown by dotted lines, fig. 9-21), called a beat-frequency oscillator, is required.

### Signal Interception

The receiving antenna intercepts a small portion of the passing radio waves. The signal

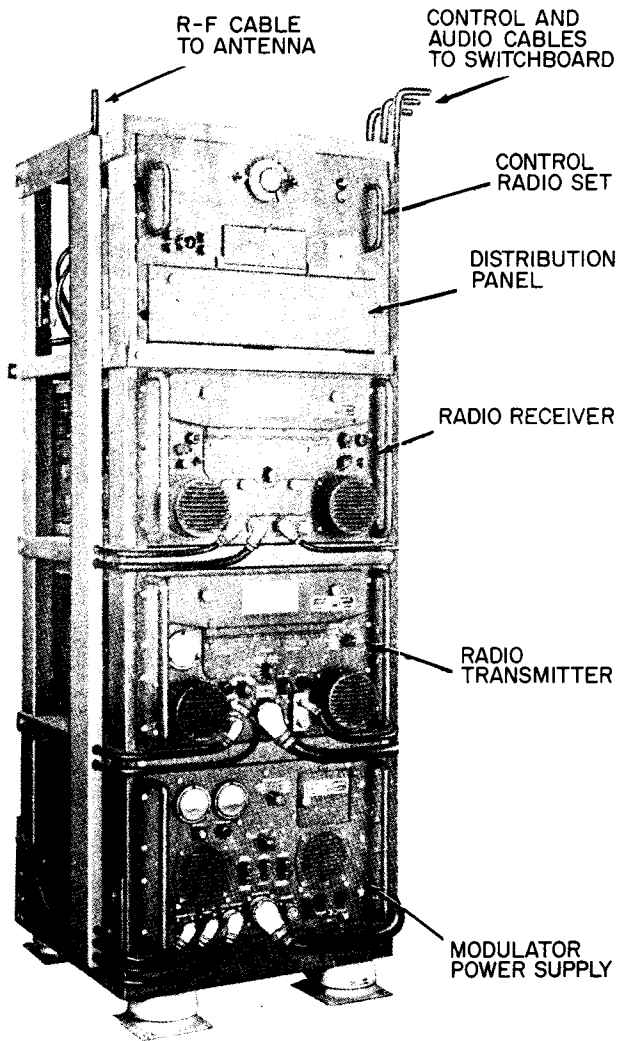

32.109.2

Figure 9-20. —UHF transmitter-receiver AN/GRC-27A.

voltage extracted by receiving antennas is only a few microvolts, sufficient for subsequent amplification as long as the noise energy intercepted by the antenna is substantially less than this.

### SIGNAL SELECTION

Some means must be provided to select the desired signal from all r-f carriers intercepted by the antenna. This selection is made by tuned circuits that pass only their resonant frequency (frequency to which the receiver is tuned) and reject other frequencies. Thus the

receiver is able to differentiate between the desired signal frequency and all other frequencies.

### RADIOFREQUENCY AMPLIFICATION

The weak signals intercepted by the antenna usually must be amplified considerably before the intelligence contained in them can be recovered. One or more r-f amplifiers serve to increase the signal to the required level. A tuned circuit in each r-f amplifier makes sure that only the desired signal is amplified.

### DETECTION (DEMODULATION)

If the signal is amplitude-modulated, the original intelligence must be recovered from it by separating the modulation signal from the r-f carrier. The circuit that separates the audiofrequency signal variations from the r-f carrier is called the detector or demodulator. Most detectors do not operate well at very low signal levels, and this is one of the reasons why r-f amplification is required ahead of the detector.

In CW (radiotelegraphy) reception, a beat-frequency oscillator (bfo) is used in the receiver circuit. The bfo provides an r-f signal that beats or heterodynes against the frequency injected into the detector. The resultant frequency is an audiofrequency that can be heard in the headset or loudspeaker.

### AUDIOFREQUENCY AMPLIFICATION

The signal frequency in the output of the detector generally is too weak to operate a headset or loudspeaker. One or more stages of a-f amplification are therefore required to strengthen the audio output of the detector to a level sufficient to operate the headset or loudspeaker.

### SOUND REPRODUCTION

The amplified a-f signal is applied to the headset or loudspeaker that translates the electrical a-f variations into corresponding sound waves. For a-m, the sound output of the speaker is a close replica of the original audio sounds at the transmitter. For CW, the sound is a tone the frequency of which depends upon the frequency of the beat-frequency oscillator. This tone is heard whenever the key is

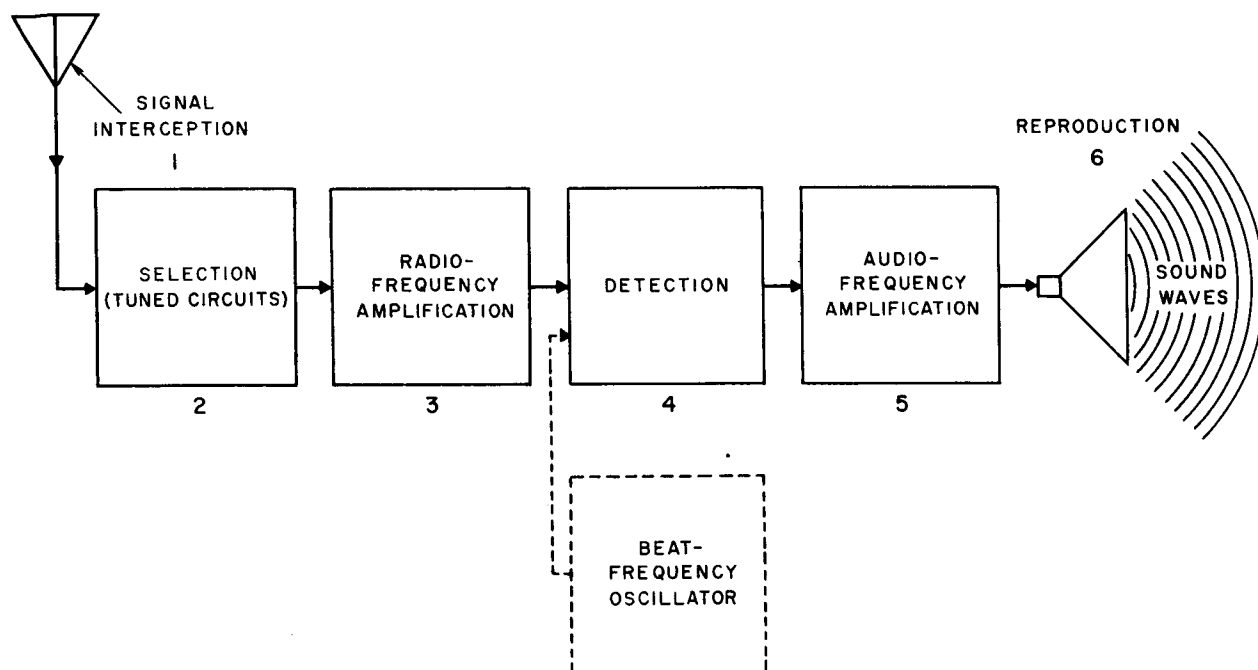

76.23

Figure 9-21. — Essentials of radio reception.

depressed at the transmitter, and, consequently, it reproduces the interruptions of the r-f carrier in accordance with the Morse code.

#### FIELD STRENGTH

The amount of voltage induced in an antenna depends upon the length of the antenna and the strength of the carrier wave at that point. The carrier wave, strongest when it leaves the transmitting antenna, is attenuated (weakened) as it travels until its energy level, called field strength, is too weak to be received. The amount of voltage induced in an antenna depends on the length of the antenna as well as upon the field strength of the signal.

#### SENSITIVITY

The sensitivity of a receiver is a measure of how well it can amplify weak signals. Communication receivers are highly sensitive and can operate on far weaker signals than a home radio.

In an area of strong local interference, a receiver needs a strong signal to give good reception. If the local interference has a field strength of 100 microvolts per meter, a signal

strength of from 500 to 1000 microvolts per meter is required to drown the noise. The same receiver, free of local interference, may give good reception on a signal strength of 10 microvolts per meter. It is hard to state the exact minimum field strength needed to operate a receiver satisfactorily, but many sets under ideal conditions can function on a signal strength of from 1 to 3 microvolts per meter. To bring such a signal to an audible level requires an amplification of many millions of times.

#### SELECTIVITY

Selectivity is the ability of a receiver to respond to one particular signal and to reject all others. A very selective receiver is said to tune sharply.

Some types of receivers are more selective than others. A radiotelephone communication receiver tunes more sharply than a commercial broadcast receiver, and a CW communication receiver is even more selective. You can compare the three tuning curves in figure 9-22.

You will remember the analysis of amplitude modulation treated earlier in this chapter. It showed how the intelligence transmitted was contained in the sideband frequencies.

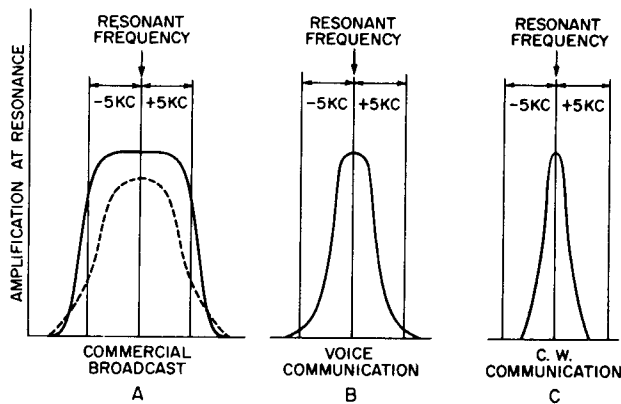

76.24

Figure 9-22. — Tuning curves of three types of radio receivers.

Carrier waves from commercial broadcast stations contain sideband frequencies that extend 5 kc on either side of the carrier frequency. If a station is transmitting on 1140 kc, the complete carrier wave contains frequencies from 1135 to 1145. If a receiver tunes too sharply, some of the sideband frequencies are lost, with a corresponding sacrifice of fidelity. The commercial broadcast receiver tuning curve shown in figure 9-22 is OPTIMUM— "at its best." The top is broad and flat and the sides are steep. Actually, most a-m broadcast receivers have tuning curves resembling the broken line, and many frequency components of voice and music contained in the signal are not reproduced by the set.

Although sharp tuning in a home radio would make for poor listening, it is desirable for military sets for the sake of frequency economy and reduction of interference. Radiotelephone messages can be sent on frequencies that extend only 2 kc on either side of the carrier frequency. The voice may sound unnatural, like a voice on the telephone, but it can be understood.

The CW sets tune so sharply that, unless an operator is careful, he can turn his dial through the signal without even hearing it.

## TYPES OF RECEIVERS

The two major types of communication receivers are the TUNED RADIOFREQUENCY (TRF) and the SUPERHETERODYNE.

### TUNED RADIOFREQUENCY RECEIVER

In the TRF receiver, all radiofrequency amplification takes place at the frequency of

the incoming signal, and all tuned circuits must be adjusted to this frequency. For this reason, the TRF receiver has several disadvantages. It is difficult to get uniform amplification of the r-f stages over the entire frequency range of the receiver. At the higher frequencies, the sensitivity of the receiver is reduced. The most serious drawback of the TRF receiver is that the selectivity of the tuned circuits cannot be kept uniform over the frequency range, the selectivity decreasing at the high end of the frequency band. The TRF receiver is rarely used any more. The Navy models RAK/RAL and RBA receivers, although obsolete and scheduled for early replacement, still are installed and in use in some ships and stations. These models are the only TRF receivers you are likely to encounter.

## SUPERHETERODYNE RECEIVER

The difficulties of the TRF receiver are overcome to a large degree in the superheterodyne receiver by conversion of the signal frequency to a lower intermediate frequency (i-f). Regardless of the frequency of the received signal, the signal with its audio modulation is always converted to this fixed intermediate frequency. Then it can be amplified in a fixed-frequency i-f amplifier. This amplifier has much higher and more uniform amplification and selectivity over the tuning range of the receiver than is possible with the TRF amplifier. Summing up, the superheterodyne receiver is superior to the TRF receiver, because it is more selective, has higher amplification, and more uniform selectivity and sensitivity. In addition to these advantages, it has fewer variable-tuned circuits, and the receiver can more easily be made to cover more frequency bands. For these reasons, superheterodynes have replaced TRF receivers for practically all uses.

### BASIC SUPERHETERODYNE RECEIVER

The basic stages for a-m superheterodyne reception are shown in figure 9-23 in the order in which a signal passes through the receiver. The illustration also shows the changes in waveshape of the signal as it passes through the receiver. The operation of the superheterodyne receiver for the reception of a-m signals is as follows:

1. Modulated r-f signals from many transmitters are intercepted by the antenna.



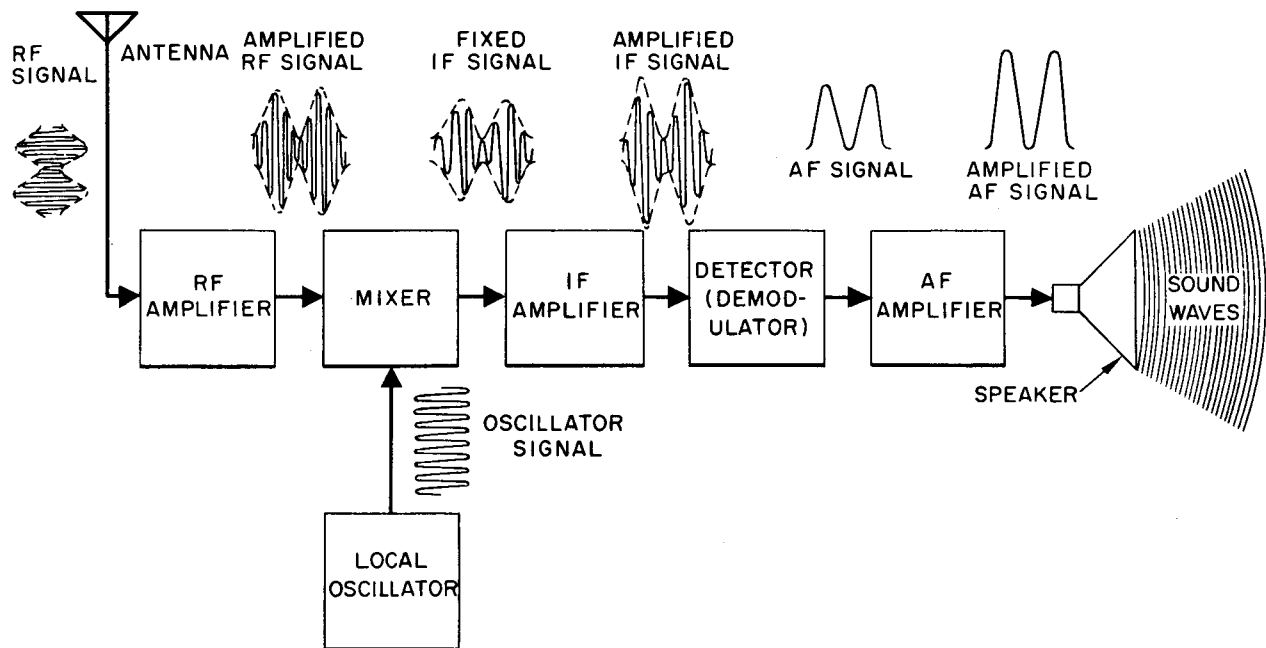

76.25

Figure 9-23. — Superheterodyne receiver, showing signal waveshape.

They are fed to the first stage of the receiver, which is a variable-tuned r-f amplifier.

2. The desired r-f signal is selected by the tuning circuit of the r-f amplifier. This signal is amplified, and all other signals are rejected to some degree.

3. The amplified r-f signal is coupled to the mixer stage, where it is combined with the output of the local oscillator. In this process of heterodyning (mixing), two new frequencies are produced. One is equal to the sum of the incoming signal and the local oscillator; the other equals the difference between the incoming signal and the local oscillator frequencies. Most receivers are designed with selective circuits to reject the sum frequency; the difference frequency is used as the intermediate frequency (i-f). It contains the same modulation as the original r-f signal.

4. The i-f signal is amplified in the fixed-tuned i-f amplifier stages and is coupled to the detector.

5. The detector stage removes the audio modulation contained in the i-f signal and filters out the i-f carrier, which no longer is needed.

6. The resulting audio signal is amplified to the level required by the loudspeaker.

7. The electrical audio variations are converted into the corresponding sound waves by the loudspeaker (or headphones).

#### FREQUENCY CONVERSION

The oscillator and mixer circuits together achieve the frequency conversion of an r-f signal to an intermediate frequency. Two methods are used to produce this frequency conversion. In one, a separate oscillator tube provides the local oscillations. The output of this tube is injected into another tube. The incoming r-f signal also is injected into this second tube along with the local oscillations, where they combine to produce the intermediate frequency. The tube in which the two signals are combined is called the mixer. The distinguishing feature of this method is that two separate tubes are required.

In the second method, only one tube, known as a converter, is used. The oscillator and mixer tubes are combined into a single tube that performs both functions. The advantage of this method is that only one tube is necessary.

Many modern Navy receivers in the HF, VHF, and UHF ranges make use of two intermediate frequencies. This is known as double

conversion. For example, the incoming signal first may be converted to an intermediate frequency between 5 and 10 mc, and after amplification, this frequency is again converted to a lower i-f between 2 and 5 kc. A receiver that makes use of double conversion is called a double superheterodyne receiver. A few models of receivers make use of three intermediate frequencies (called triple conversion).

The specific frequency used for the i-f is not the same for all the different models of receivers. You can find the i-f for a particular model in the equipment technical manual.

### CW Detection

Because CW code signals are not modulated, the intelligence contained in them cannot be recovered by the ordinary detection process. The addition of a beat-frequency oscillator (bfo), shown in figure 9-21, is all that is required to make an a-m superheterodyne receiver suitable for the reception of CW signals. When the oscillator is switched on by means of the bfo switch, its output heterodynes with any incoming CW signal to produce an audio beat note. The receiver can be made ready again instantly for a-m reception by simply turning off the bfo. All Navy communication receivers in the VLF through HF ranges have a bfo.

### Volume Control

Volume or gain controls are provided in receivers to permit changing the receiver sensitivity. This identical device is found on home radios and televisions and is familiar to everyone. It is necessary in order to compensate for differences in the strength of incoming signals.

Volume control can be manual or automatic. Automatic volume control (AVC)—sometimes called automatic gain control (AGC)—is used in all superheterodyne receivers and is desirable for several reasons. One reason is that it prevents extreme variations in loudspeaker volume. When a receiver is tuned from a weak station (for which the volume has been turned up) to a strong station, the loudspeaker (or headset) will blast unpleasantly. The variations in signal strength due to fading also cause wide fluctuations in loudspeaker volume. Furthermore, variations in signal strength at the antenna, if not compensated for, can cause serious trouble by overloading the

r-f, i-f, or detector stages of the receiver. Overloading causes distortion of the signal.

The AVC keeps the output volume at a constant level by reducing the amplification of certain stages in the receiver as the amplitude of a received signal increases. It affects weak as well as strong signals. When a receiver is tuned, the AVC usually is switched off to afford maximum amplification of weak signals. After tuning, the AVC is turned on, provided the signal is not too weak.

In some receivers a special type of AVC, called delayed automatic volume control (DAVC), is used. The DAVC-equipped receivers do not reduce amplification of a signal until a certain level is exceeded. In this way very weak signals are not further weakened.

### Noise Discrimination

Highly sensitive modern superheterodyne receivers always have some background noise that appears in the output as hiss and crackles. Some noise arises in the receiver itself; other noises are produced by lightning and man-made interference such as that caused by electric motors. Noise interference is bothersome at best, and at worst causes fragmentary reception. A number of devices are designed to minimize the effects of interference.

The noise suppressor works similar to the tone control on a home receiver. When this control is tuned for bass reception, much of the noise is filtered out and is not permitted to reach the earphones. But the noise suppressor also reduces the volume, so that on weak signals it may be necessary to throw the switch that cuts the suppressor out of the circuit.

The output limiter prevents sudden crashes of static from injuring the operators eardrums. There are several types, but all work as a safety valve. When the output volume of sound reaches a certain level, the limiter is activated and prevents the sound from rising any higher.

Some receivers have silencer circuits that keep the set quiet when no signal is coming in. This is a convenience when standing by for a message, and also saves you the discomfort of spending a slack watch listening to static.

Most output limiters and silencers have OFF-ON switches and an output level adjustment. The specific names for these controls are not the same on all receivers. It is necessary to read the technical manual and examine

the equipment before you attempt to tune any particular receiver for the first time.

### REPRESENTATIVE RECEIVERS

Radio receivers AN/SRR-11, -12, -13, and -13A (fig. 9-24) are representative modern communication receivers used in all types of Navy vessels. They are companion receivers to the previously described transmitters AN/SRT-14, -15, and -16, and cover frequencies between 14 kc and 32 mc. A general description of these receivers is followed by an

explanation of the common operating adjustments, and this is concluded with a summary of the tuning procedures.

A number of other receivers also are briefly described and illustrated in this section.

### AN/SRR-11, -12, -13 RECEIVERS

The frequency range of each receiver is divided into five bands. The frequency range of the AN/SRR-11 is from 14 to 600 kc, that of the AN/SRR-12 is from 0.25 to 8 mc, and the range of the AN/SRR-13 and -13A is from 2 to 32 mc.

You may have noticed that the frequency range of AN/SRR-12 includes the standard broadcast band, and overlaps part of the frequencies covered by the other models. The Navy procured very few AN/SRR-12 receivers, and it is unlikely that you will encounter this model in the fleet. Although the tuning procedures for AN/SRR-12 and 13 are the same, further discussion will mention only models AN/SRR-11 and -13. AN/SRR-13A differs only slightly and statements regarding AN/SRR-13, except where specifically noted, apply to 13A as well.

The AN/SRR-11 receiver is used for guarding low and medium frequencies, such as the international distress frequency, 500 kc, but its most general use is for receiving the VLF and LF transmissions of the fleet broadcasts. This receiver can be used for CW, MCW, RATT, and frequency-shift RATT and FAX reception.

The AN/SRR-13 covers all of the HF band, and, in addition to receiving CW, MCW, RATT, and FAX, it is an exceptionally good radio-telephone receiver.

Both AN/SRR-11 and -13 are double super-heterodyne receivers. A crystal-controlled calibrator in each receiver provides crystal checkpoints for the frequency dial. These checkpoints are spread uniformly over the tuning range of the receivers and occur at 10-kc intervals for the AN/SRR-11, and at 200-kc intervals for AN/SRR-13. The use of the frequency checkpoints in calibrating the tuning dial is explained in the tuning procedures.

The frequency to which the receiver is tuned appears projected on a translucent screen (tuning dial) located at the upper left of the front panels (fig. 9-25). The dial is calibrated in kilocycles on the AN/SRR-11 and in megacycles on the AN/SRR-13.

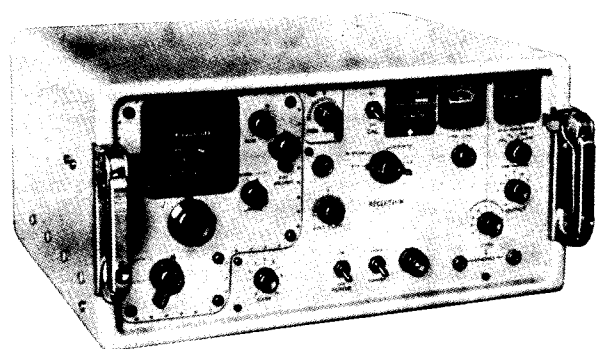

A AN/SRR-11

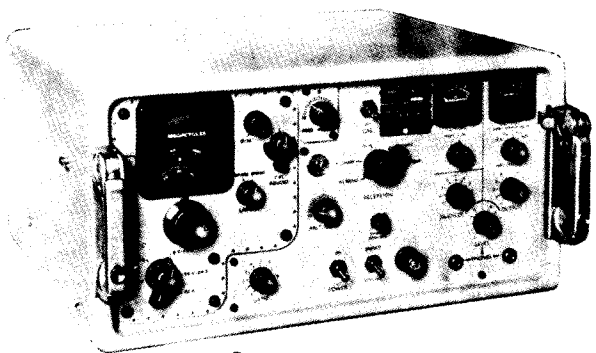

B AN/SRR-12 AND 13

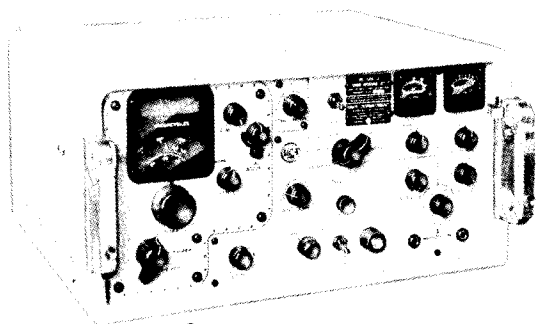

C AN/SRR-13A

Figure 9-24. — AN/SRR-11, -12, -13, and -13A receivers. 1. 157

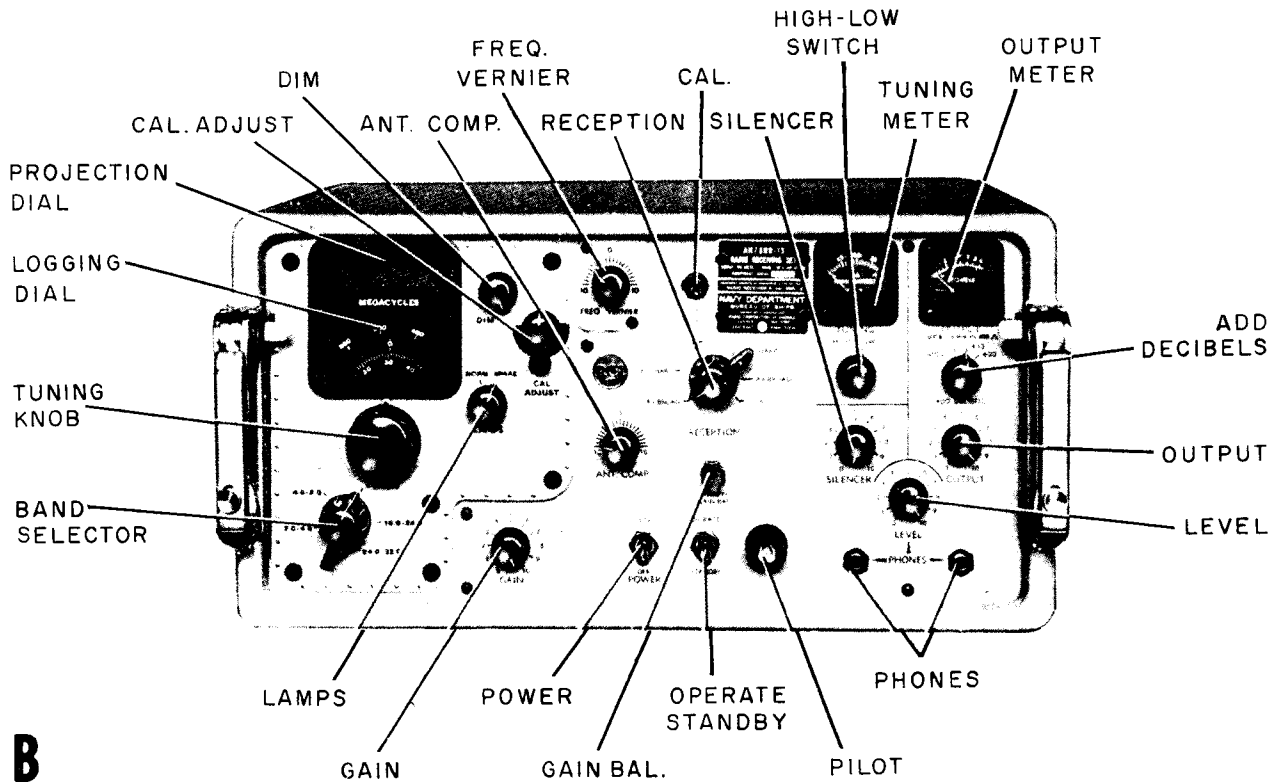
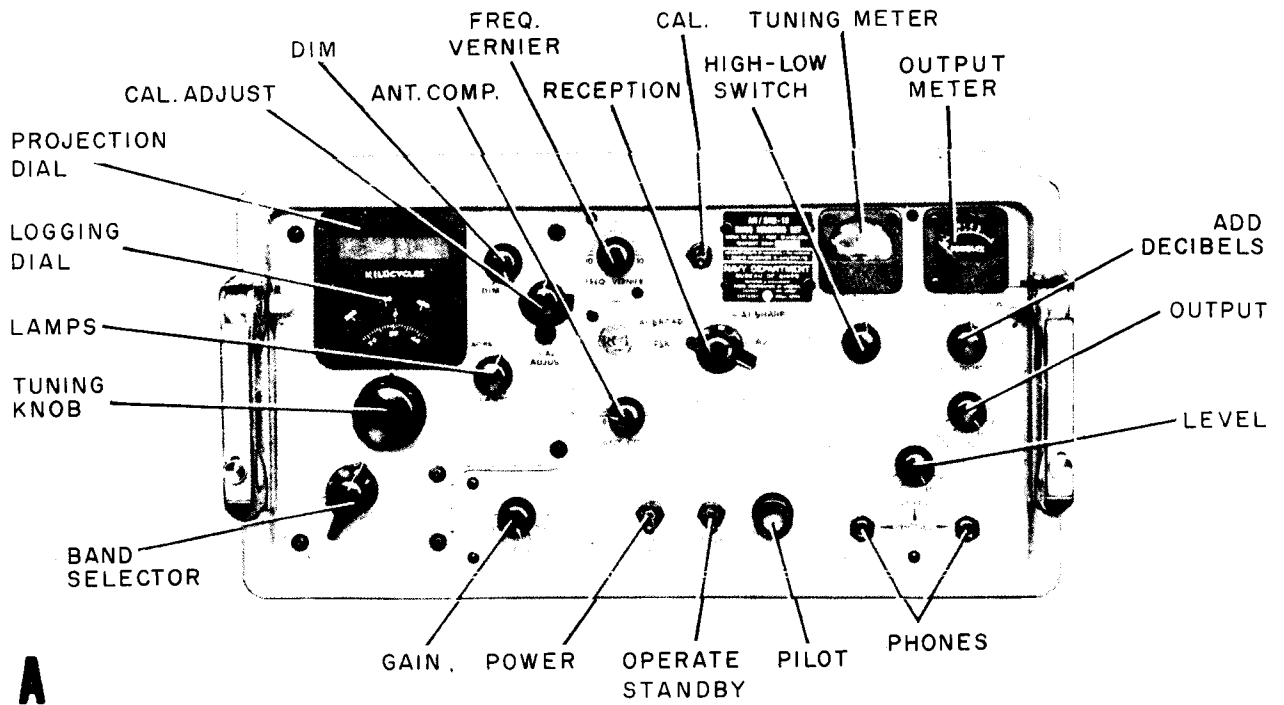

Figure 9-25. — (A) AN/SRR-11 receiver.  
(B) AN/SRR-13 receiver.

## Operating Adjustments

The name of each control is marked on the front panel, as illustrated in figure 9-25.

The on-off POWER switch turns the receiver on. The OPERATE-STANDBY switch (not included in model AN/SRR-13A) must also be turned on to apply plate voltage to the tubes.

The GAIN control operates in both the r-f and i-f stages of the receiver. Maximum gain is obtained with the control knob turned fully clockwise.

The ANT COMP (antenna compensating) control provides a tuning adjustment for the antenna preamplifier, to compensate for variations in antenna length.

The BAND SELECTOR provides selection of the tuning range in any one of five bands. The TUNING KNOB is used to tune the receiver to the desired frequency. The indication of this frequency appears on the translucent screen above the tuning knob, as previously described.

The DIM control varies the brightness of the dial light. The LAMPS switch connects a spare dial light in the event of burnout of the first one.

The OUTPUT control varies the volume of the audio amplifier. The LEVEL control is used to vary the volume in the headphones.

The RECEPTION control on the AN/SRR-11 receiver is a four-position switch used to select the proper circuits for the type of signal being received. The FSK position is used for receiving frequency-shift signals, either RATT or FAX, when a converter is connected to the receiver; a beat note is furnished. The A1 BROAD setting is the normal setting for CW signals; a beat note is also provided. The A1 SHARP setting is used to separate CW signals by narrowing the frequency response; a beat note is also provided. The A2 position is used for receiving MCW signals. In addition to the four signal positions on the AN/SRR-11 reception control, the corresponding switch on the AN/SRR-13 receiver has two additional settings. These are designated A3 SHARP and A3 BROAD. Both settings provide circuits for reception of radiotelephone signals.

The SILENCER reduces background noise when the RECEPTION control is set at A3 SHARP or A3 BROAD, and the desired station is not transmitting.

The FREQ VERNIER varies the pitch of the beat-frequency oscillator when the RECEPTION control is in the A1 BROAD, A1 SHARP, and FSK positions.

When CAL (calibrate) switch is turned on, frequency checkpoints are provided. The CAL ADJUST control is used to reset the projection dial after the desired checkpoint frequency has been zeroed.

The TUNING METER reads up scale (to the right) when the desired signal is tuned to maximum. The meter reads down scale (toward the left) when the desired station is detuned. The tuning meter is used in conjunction with the HIGH-LOW switch. It normally is in the LOW position. When the tuning meters reads on the lower part (left side) of the scale in the LOW position of the switch, use the HIGH position and tune the receiver for an up-scale reading on the meter. The HIGH position of the switch is spring-loaded; when released, the switch returns to the LOW position.

The OUTPUT METER reads the output power level when used in conjunction with the ADD DECIBELS switch.

The ADD DECIBELS switch is used to protect the output meter circuit against overload. Use the +10 position for checking strong output levels. The 0 position is used to measure weak levels, and the -10 position is used for a momentary reading of weak levels. The ADD DECIBEL switch should be in the +20 position when not using the output meter.

## Summary of Operation

When starting the equipment: (1) turn POWER switch ON, (2) turn OPERATE-STANDBY switch to OPERATE, (3) adjust dial illumination with DIM control (turn clockwise to brighten; should the dial light burn out, switch LAMPS knob to SPARE position), (4) turn ADD DECIBELS switch to +20 position, (5) make sure the CAL switch is OFF, and (6) plug a headset into either of the two PHONES jacks. The LEVEL control adjusts the volume in the headphones.

To tune a signal:

1. Turn the GAIN and OUTPUT controls clockwise until background noise is heard.
2. Turn the SILENCER control fully counterclockwise. This control is effective only when the RECEPTION control is set at A3 SHARP or A3 BROAD. (The AN/SRR-11 is not designed for radiotelephone reception, hence does not have the SILENCER control.)
3. Set BAND SELECTOR switch to the appropriate frequency band.
4. Calibrate the receiver at the nearest frequency checkpoint. To calibrate the receiver,

turn CAL switch ON. Set the tuning dial at the nearest calibration marker (marked by an inverted V on the frequency scale). Rock the tuning knob slightly on both sides of the chosen frequency until a beat note is heard. Zero beat should occur at the calibration marker chosen. If zero beat does not occur at this marker, adjust the tuning knob until zero beat is heard. Then, loosen the thumbscrew holding the CAL ADJUST knob, and turn the knob until the nearest calibration marker is under the hairline on the projection screen. Tighten the thumbscrew over the CAL ADJUST knob. Turn the CAL switch OFF. The dial reading will now be very accurate for frequencies near the calibration marker.

5. Tune in the desired station by setting the frequency under the hairline index on the dial projection screen by means of the TUNING KNOB.

6. If the station is not heard at this setting of the dial, rock the dial a short distance about this point to search for it. After you find the desired station, turn ANT COMP (antenna compensating) control until the signal is the loudest. Adjust the signal to maximum indication on the TUNING METER.

Other tuning procedures vary, depending on the class of emission and consequent setting of the RECEPTION control.

**CW RECEPTION.**—Set RECEPTION control to A1 BROAD. Adjust GAIN to point of loudest signal and lowest background noise. Then adjust OUTPUT to a comfortable listening level. Use the LEVEL control to adjust headphone volume. Adjust FREQ VERNIER to a pleasant audio pitch. (A pleasant audio note varies with the individual operator's preference, so adjust it to suit yourself.)

The A1 BROAD position of the RECEPTION control should be used for receiving CW signals whenever possible. However, the A1 MEDIUM (on AN/SRR-13A only) and A1 SHARP settings should be used when necessary to eliminate adjacent signals that crowd the desired station's signal.

**RADIOTELEPHONE RECEPTION.**—Set RECEPTION control at A3 BROAD or A3 SHARP (these positions are not included in AN/SRR-11). In these positions, the GAIN is automatically maximum and operating the GAIN control has no effect. Tune the signal to maximum reading of the TUNING METER. Adjust OUTPUT control to proper listening level. To eliminate background noise, start with the SILENCER

control fully counterclockwise, then rotate the SILENCER until background noise is eliminated with the desired signal remaining undistorted.

**RATT AND FAX RECEPTION.**—For receiving frequency-shift RATT and FAX, the RECEPTION control is set at FSK. Normal tuning procedures are followed, except that adjustment of the OUTPUT and FREQ VERNIER controls vary for different types of converters used for RATT and FAX reception.

### RBA, RBB, AND RBC RECEIVERS

The RBA, RBB, and RBC receivers (fig. 9-26) have been used for many years aboard ship and at shore stations. Although they are being replaced by the AN/SRR-11, 12, and 13 series, you are likely to be working with them on your ship or station.

The total frequency coverage of these receivers is 15 kc to 27 mc—the RBA from 15 to 600 kc, the RBB from 0.5 to 4 mc, and the RBC from 4 to 27 mc.

The RBA is a TRF (tuned radiofrequency) receiver, whereas the RBB and RBC are superheterodynes. All three receivers may be used for CW, MCW, and voice signals, but the RBA is not recommended for radiotelephone use because of its high selectivity. Most RBA and RBC receivers have been adapted to receive frequency-shift RATT and FAX signals also. All three receivers have high sensitivity and good selectivity. As shown in figure 9-26, the power supplies are separate units from the receivers.

### R-390A/URR

Radio receiver R-390A/URR (fig. 9-27) is a modern, high-performance, exceptionally stable receiver for both shipboard and shore station use. It will receive CW, MCW, a-m radiotelephone, frequency-shift RATT and FAX, and SSB signals within the frequency range from 500 kc to 32 mc.

The receiver is a superheterodyne type, with multiple frequency conversion. In the frequency range from 500 kc to 8 mc it uses triple conversion; double conversion is used in the range from 8 to 32 mc.

The tuning knob turns a complex arrangement of gears and shafts to indicate the frequency to which the receiver is tuned on a very accurate counter-type indicator that resembles the mileage counter on an automobile dashboard.

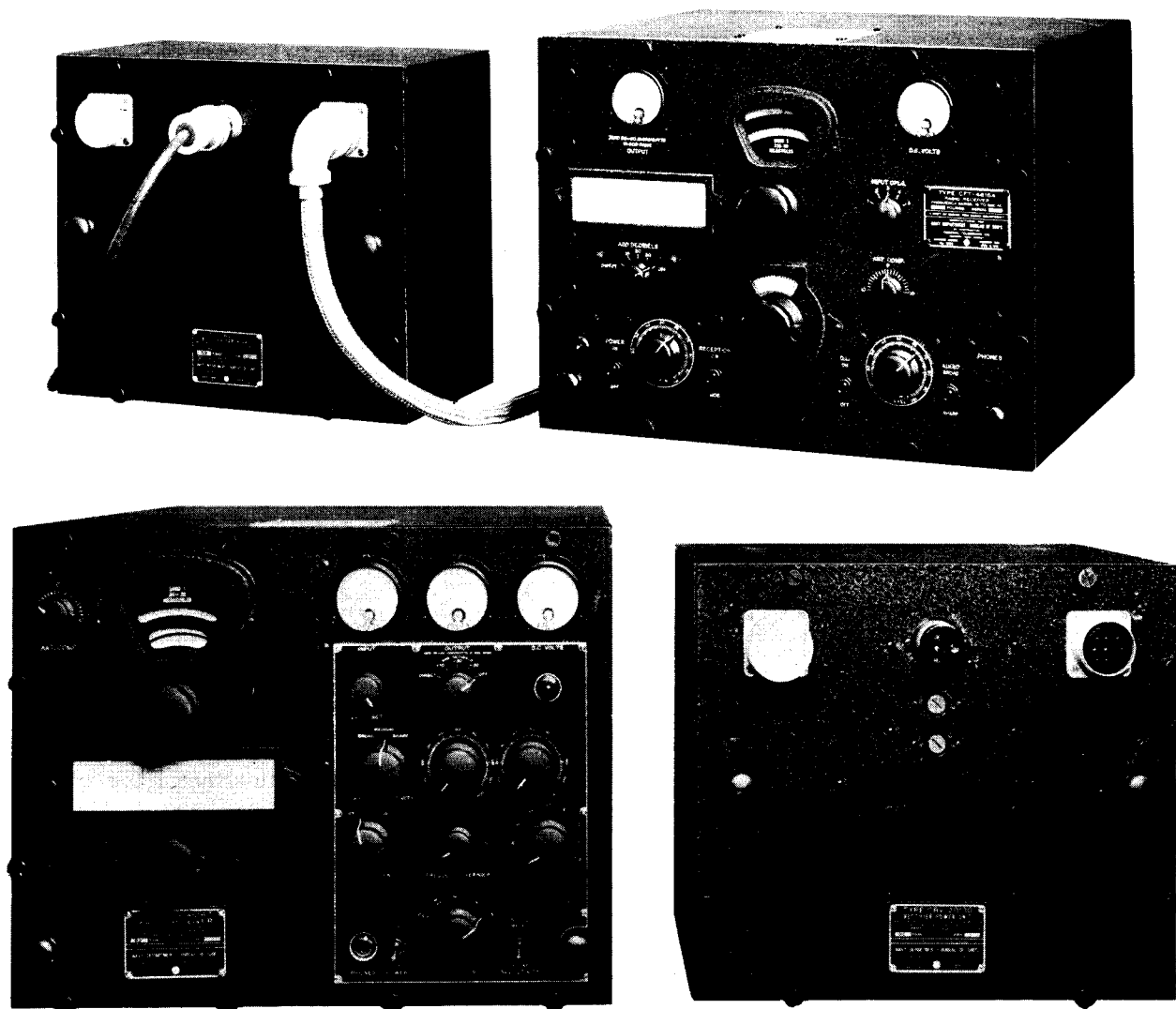

34.17(76)

Figure 9-26.— Top: RBA receiver with power supply; bottom: RBB/RBC receivers with power supply.

The dial is calibrated in kilocycles, and the frequency-reading accuracy of this tuning dial permits use of the receiver as an accurate frequency meter.

#### AN/WRR-2

One of the latest shipboard radio receivers for the medium- and high-frequency bands is the AN/WRR-2, shown in figure 9-28. (The same receiver with rack mounting for shore station use, is called AN/FRR-59.)

The AN/WRR-2 is a triple-conversion superheterodyne receiver covering the frequency range 2 to 32 mc. This modern receiver is intended primarily for the reception of single sideband transmissions with full carrier suppression. It can be used also to receive conventional amplitude-modulated signals of various types, including CW, MCW, voice, facsimile, and frequency-shift RATT.

In order to meet strict frequency tolerances, special features provide extremely accurate tuning and a very high degree of stability over

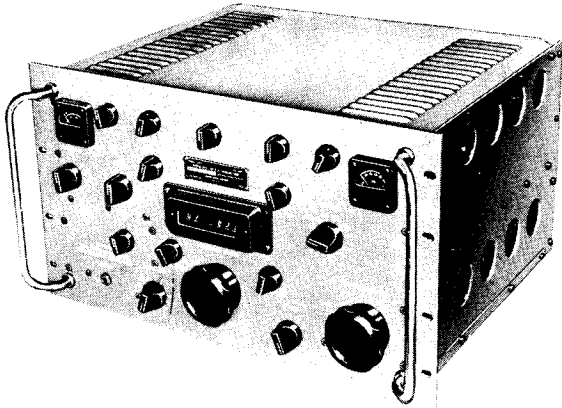

34.15

Figure 9-27.—Radio receiver R-390A/URR.

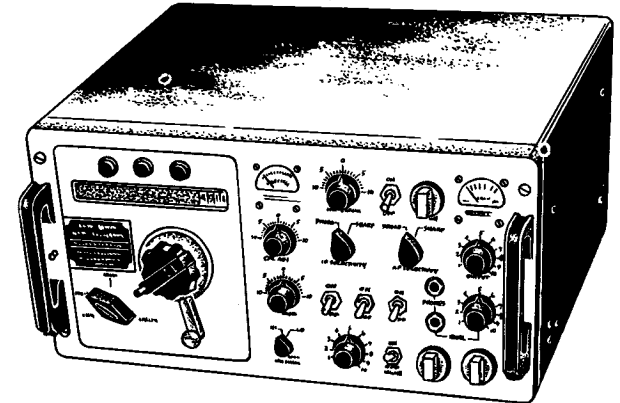

76.26

Figure 9-29.—Radio receiver AN/WRR-3.

The receiver covers the frequency range of 14 to 600 kilocycles in five bands. The bands are—

- Band 1 - 14 to 30 kc.
- Band 2 - 30 to 63 kc.
- Band 3 - 63 to 133 kc.
- Band 4 - 133 to 283 kc.
- Band 5 - 283 to 600 kc.

The frequency to which the receiver is tuned is read directly on drum-type dials.

An internal calibration circuit provides calibration points at each 10-kc tuning point within the tuning range of the receiver.

RBO

The model RBO receiver (fig. 9-30) has been the standard shipboard entertainment receiver for many years. It is installed in ships of all types.

The RBO is a superheterodyne receiver. It provides high-quality reception of voice and music. There are three frequency bands: (1) the standard broadcast band, 530 to 1600 kc; (2) a shortwave band from 5.55 to 9.55 mc; and (3) another shortwave band from 9.20 to 15.60 mc.

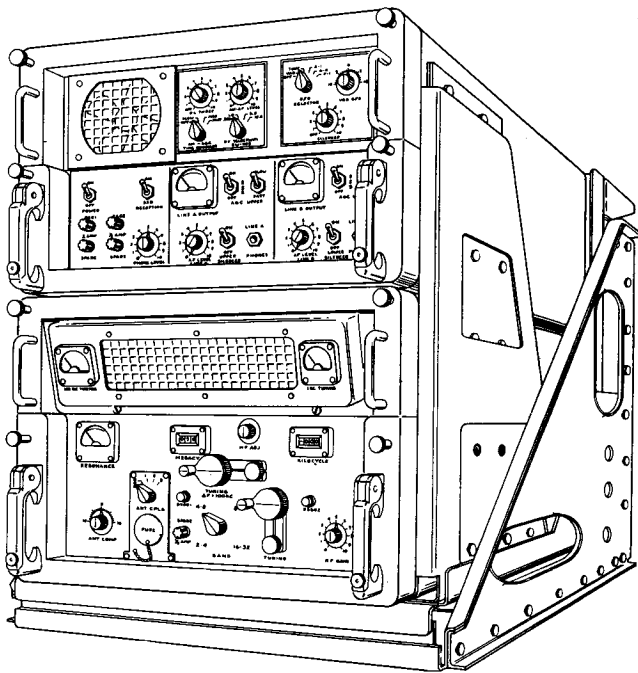

50.40

Figure 9-28.—Radio receiving set AN/WRR-2.

long periods of operation. Simultaneous use can be made of both upper- and lower-sideband channels for receiving two different types of intelligence, although both single sideband and conventional arm signals cannot be received at the same time.



## VHF RECEIVERS

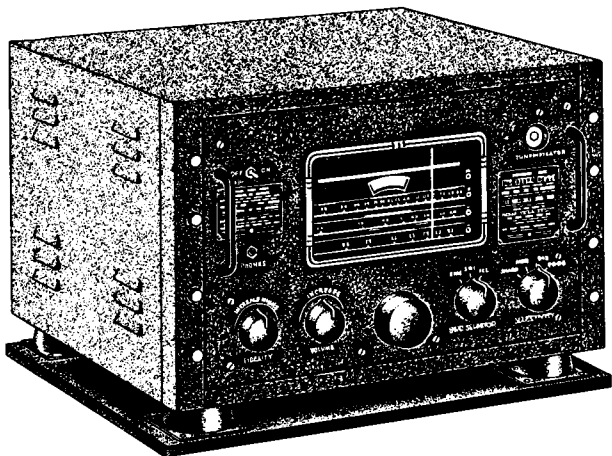

76.27

Figure 9-30.—Model RBO entertainment receiver.

## AN/URR-22

Radio receiver AN/URR-22 (fig. 9-31) is designed primarily for reception of voice transmissions on the standard broadcast and international shortwave broadcast bands. It can be used, additionally, as an emergency communication receiver for CW and MCW signals.

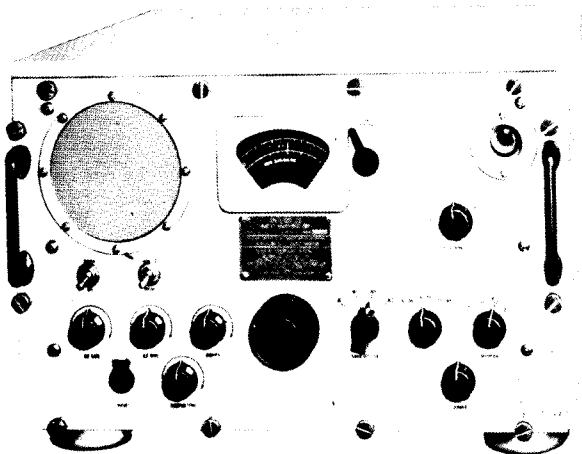

76.28

Figure 9-31.—Entertainment receiver AN/URR-22.

It is a superheterodyne receiver covering the frequency range of 540 kc to 18.6 mc in four frequency bands.



32.56

Figure 9-32.—VHF receiver AN/URR-21.

It is a crystal-controlled superheterodyne receiver. Although the receiver dial is calibrated continuously, only four channels can be tuned within the frequency range at any one time because the frequency of the oscillator is controlled by four individually selectable crystals. The four crystals are plugged into a crystal holder on the receiver chassis inside the cabinet. Special features include a front panel dial detent mechanism for rapid selection of channels, and continuous tuning of all r-f circuits by means of a single tuning control.

## AN/URR-27

The VHF receiver, model AN/URR-27, is used aboard ship and at shore stations for radiotelephone reception in the frequency range of 105 to 190 mc. It can also be used for MCW reception. It was designed primarily as a single-channel, crystal-controlled, superheterodyne receiver, although continuously variable manual tuning may also be used. There is a single tuning control for tuning to any frequency within its range, for either crystal-controlled or manual tuning. Only one crystal at a time can be plugged into the crystal holder, which is easily accessible on

the front panel of the receiver. The AN/URR-27 (not illustrated) is similar in size, appearance, and operating controls to UHF receivers AN/URR-13 and AN/URR-35, shown in figure 9-33.

Both AN/URR-27 and AN/URR-21 are installed as companion receivers with model AN/URT-7 transmitters.

### UHF RECEIVERS

Radio receivers AN/URR-13 and AN/URR-35 are used for radiotelephone and MCW reception in the range of 225 to 400 mc. Although the frequency range includes the upper portion of the VHF band, both receivers are commonly called UHF equipments, and are used as companion receivers with the model TED transmitter. They were designed primarily as single-channel, crystal-controlled receivers. Continuously variable manual tuning may also be used. These receivers are easy to tune. They feature single tuning controls for tuning to any frequency within their range, for either crystal-controlled or manual tuning. The AN/URR-13 is a superheterodyne receiver, whereas the AN/URR-35 is a double superheterodyne. Both receivers are similar in size, appearance, and operating controls. Only the AN/URR-35 is illustrated here (fig. 9-33). Both receivers are used aboard ship and at naval air and shore radio stations.

### AN/GRC-27

The AN/GRC-27 UHF receiver covers the frequency range from 225 to 400 mc. It is part of the AN/GRC-27 transmitter-receiver set and was described and illustrated earlier in this chapter.

### FACSIMILE EQUIPMENT

Facsimile (FAX) is a method for transmitting pictorial and graphic information by wire or radio and reproducing it in its original form at the receiving station. The most useful application of FAX by the Navy has been transmission of fully plotted weather charts.

Not every ship or station has facsimile equipment aboard. In those that do have it, it is not always operated by Radiomen. Some ships having Aerographers aboard are equipped only for receiving FAX broadcasts and the facsimile recorders are operated by Aerographers. Other ships do not carry Aerographers, and operation of facsimile equipment is the responsibility of Radiomen. Because of this, a brief description of a facsimile transmitter and a recorder is included in this manual. Should you be required to operate facsimile equipment, consult the equipment technical manual for complete operating instructions.

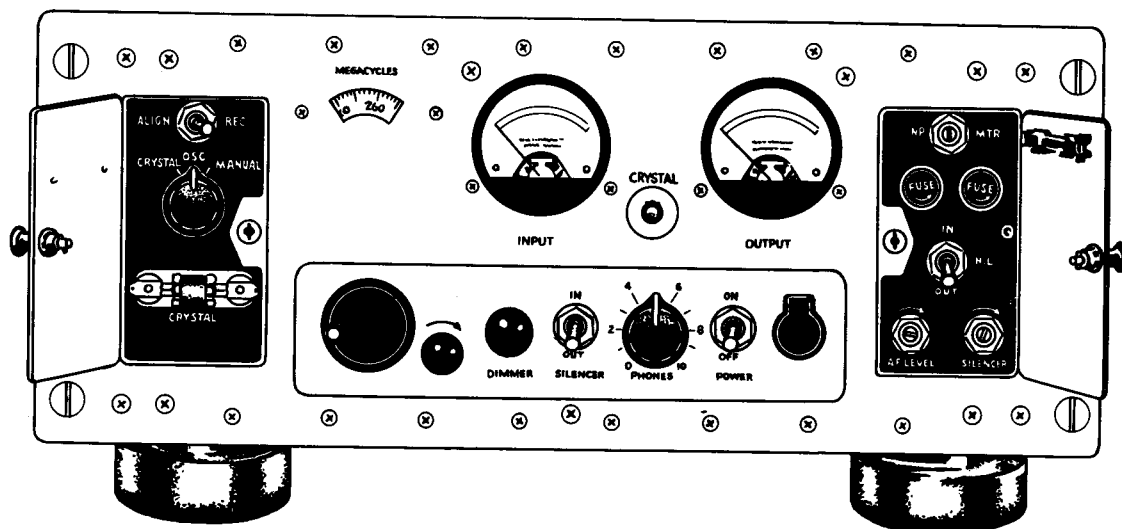

32.45  
Figure 9-33. — UHF receiver AN/URR-35.

The Navy has a number of facsimile equipments in use. All operate in much the same way. The picture to be transmitted is wrapped around a cylinder on the transmitting machine. The cylinder rotates at a constant speed and at the same time moves longitudinally along a shaft. The picture is illuminated by a beam of light focused through a lens. As the beam passes over each portion of the picture, it is reflected into a photoelectric cell, and variations in intensity of reflected light due to the character of the picture creates voltage variations in the tube output circuit. These voltage variations constitute the picture signal and may be sent directly over a landline circuit or used to modulate the radiofrequency carrier of a transmitter.

### FACSIMILE TRANSCEIVER

Facsimile Transceiver TT-41B/TXC-1B, shown in figure 9-34, is an electromechanical optical facsimile set of the revolving-drum type for both transmission and reception of page copy. Colored copy may be transmitted, but all reproduction is in black, white, and in-

termediate shades of gray. Received copy is recorded either directly on chemically treated paper, or photographically in either negative or positive form. The equipment will transmit or receive a page of copy 12 by 18 inches in 20 minutes at regular speed, or in 40 minutes with half-speed operation.

All electrical operating controls of the facsimile transceiver, except the motor speed control switch, are located on the sloping front panel (fig. 9-34). The motor speed control switch is located on the left end of the base of the transceiver. Two mechanical controls, the drum engaging lever and the clamp bar, are located on the drum. Input and output connections are located on the right end of the transceiver.

### FACSIMILE RECORDER

Facsimile Recorder RD-92A/UX, shown in figure 9-35, is used for direct stylus recording only. It cannot be used for transmitting FAX, nor can it be used to receive on photographic film, like the transceiver described earlier.

The recorder drum rotates at a speed of 60 rpm while feeding a stylus needle along the

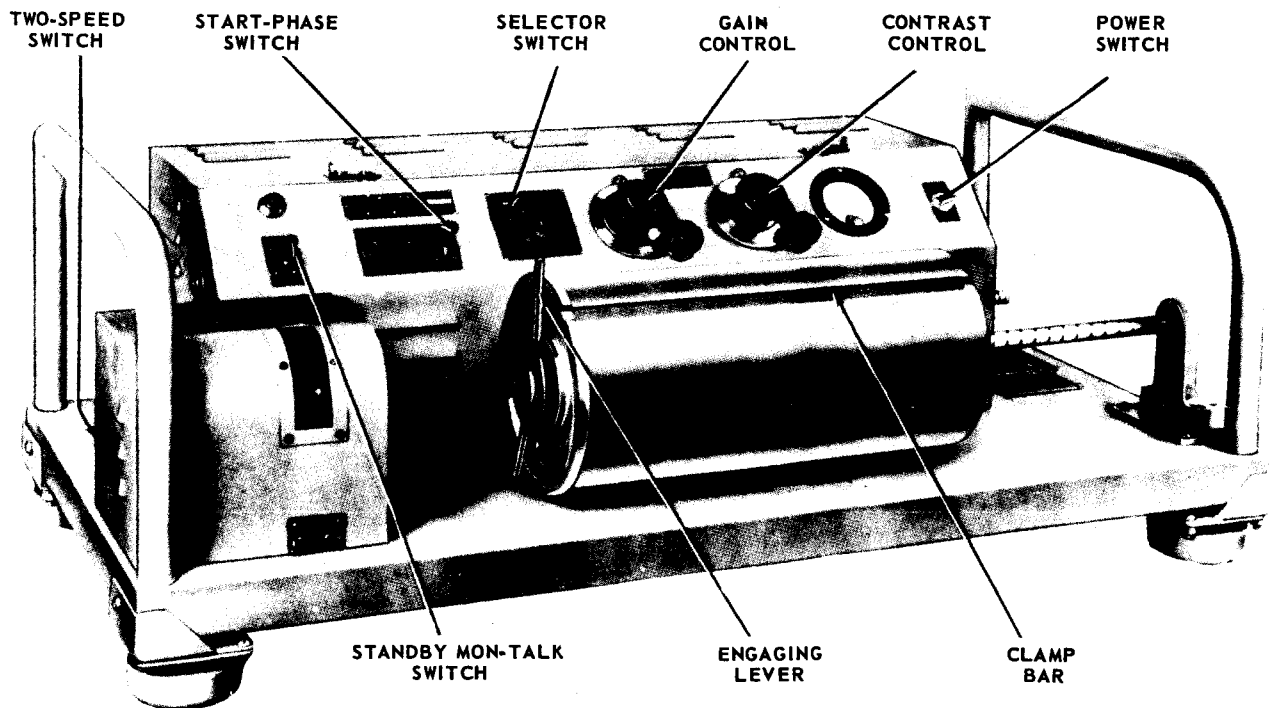

13.70

Figure 9-34. – Facsimile transceiver TT-41B/TXC-1B.

drum, one scanning line for each revolution until the complete drum has been covered.

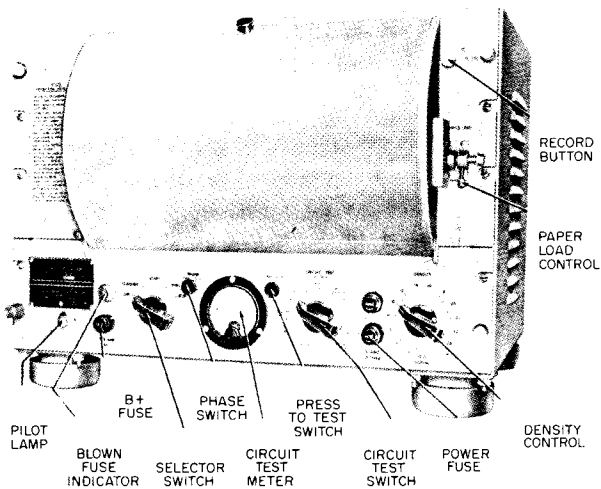

13.71

Figure 9-35. — Facsimile recorder RD-92A/UX.

When the record button (fig. 9-35) is depressed and the selector switch is in the RUN position, the stylus needle records on paper fastened on the drum. The stylus is held in a carriage assembly that is moved across the drum to the right when engaged with a lead-screw shaft geared to the drum. When the carriage assembly reaches the right end of the recorder paper, it operates an automatic release mechanism, which disengages the carriage mechanism from the lead screw and lifts the stylus from the paper. A return spring then pulls the carriage back to the left side of the drum so that it will be ready for the next copy.

#### RECEIVER AND TRANSMITTER TRANSFER SWITCHBOARDS

Radio remote control transfer plug panels have become too cumbersome to be used in the vastly expanded shipboard radio installations in modern Navy ships. Control panels utilizing switches instead of plugs and patch cords are therefore installed in new construction and conversion ships. Two unit-constructed panels (one for receivers and one for transmitters) now provide all the facilities that were available in three types of plug panels formerly used, and in addition afford greater flexibility in the remote-control system.

Receiver Transfer Switchboard, type SB-82/SRR, and Transmitter Transfer Switchboard, type SB-83/SRT, are both highly flexible in their method of operation. These two types are described here.

#### RECEIVER TRANSFER SWITCHBOARD

Receiver Transfer Switchboard, type SB-82/SRR, is shown in figure 9-36. The receiver switchboard has five vertical rows of ten double-pole, single-throw (ON-OFF) switches that are continuously rotatable in either direction. One side of each switch within a vertical row is wired in parallel with the same sides of the other nine switches within that row. Similarly, the other side of each switch is wired in parallel horizontally with the corresponding sides of each of the other four switches in a horizontal row. This method of connecting the switches permits a high degree of flexibility.

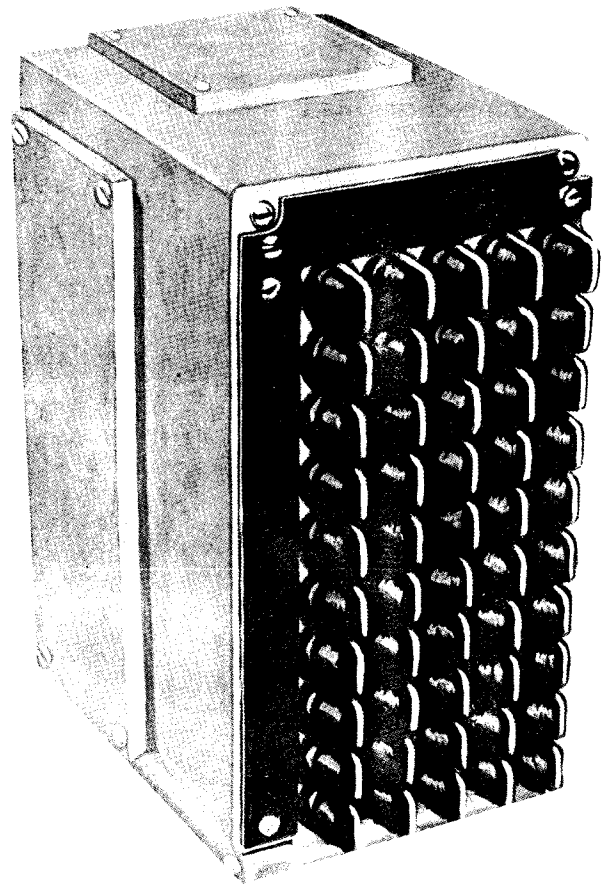

36.69

Figure 9-36. — External view of the Receiver Transfer Switchboard, type SB-83/SRT.

The audio output from five radio receivers, connected to the five vertical rows of switches, may be fed to any or all of the remote stations by closing the proper switch or switches.

The knob of each switch is marked with a heavy white line to provide visual indication of the communication setup. In general, there are more remote stations than radio receivers, hence the switchboards are normally mounted in a vertical position (as in fig. 9-36). This arrangement permits the outputs from five receivers to be fed to the five vertical rows and up to ten remote stations to be fed from the ten horizontal rows of switches. Switchboards are always installed with the knobs in the OFF position when the white line is vertical. To further standardize all installations, receivers are always connected to the vertical rows of switches, and remote stations are always connected to the horizontal rows.

Identification of the receivers and remote stations is engraved on the laminated bakelite label strips fastened along the top and left edges of the panel front.

It should be noted that only the receiver audio output circuit is connected to the switchboard. Transmitter transfer switchboards, however, handle several other types of circuits in addition to audio circuits.

#### TRANSMITTER TRANSFER SWITCHBOARD

Transmitter Transfer Switchboard, type SB-83/SRT, is shown in figure 9-37. The same parallel wiring of the switches is used as in the receiver switchboard.

The transmitter switchboard has five vertical rows of ten 12-pole, single-throw switches continuously rotatable in either direction. Radio transmitters are wired to the five vertical rows and remote stations are connected to the ten horizontal rows. Switches are OFF when the white lines on the knobs are vertical.

As has been stated, the receiver switch panel carries the receiver audio output circuit only; in this respect, it is similar to the older receiver switchboard, however, each switch carries the START-STOP INDICATOR, and KEYING circuits (six conductors), as in the old-style transmitter transfer plug panel. In addition, the transmitter switchboard carries the 12-VOLT DC MICROPHONE, CARRIER CONTROL, and CARRIER INDICATOR CIRCUITS that formerly were carried in the radiophone

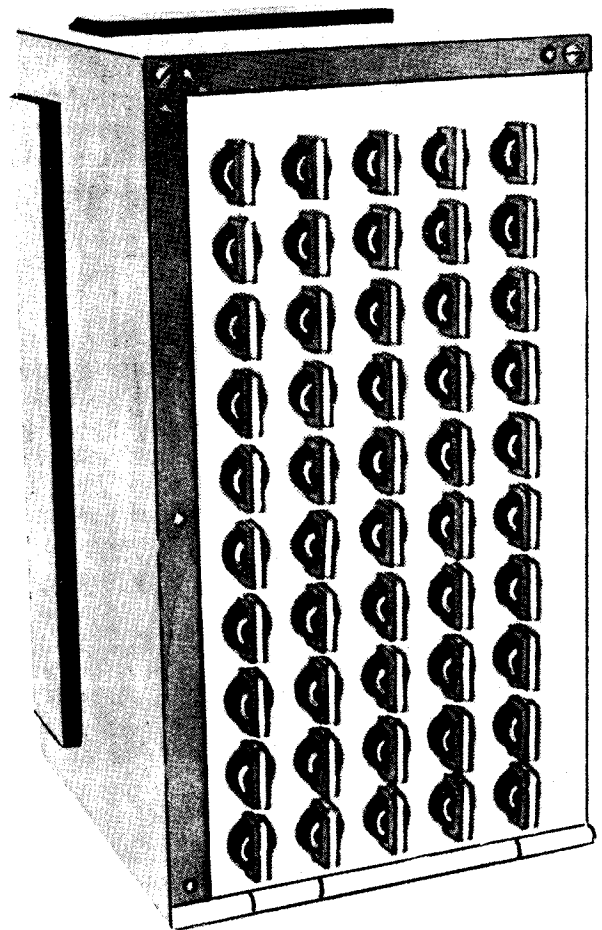

36.70

Figure 9-37. —External view of the Transmitter Transfer Switchboard, type SB-83/SRT.

transfer plug panel. Thus, the transmitter switchboard takes the place of two transfer plug panels (the transmitter plug panel and radiophone transfer plug panel).

A mechanical interlock arrangement prevents additional switches in each horizontal row from being closed when any one of the five switches in that row has been closed already. This arrangement prevents serious damage that is certain to result from two or more transmitters feeding a single remote station at the same time. Although the mechanical interlock will prevent closing a second switch in a horizontal row after one switch has been closed,

it will not prevent two switches from being turned at the same time. In other words, by using both hands, you could make the mistake of turning two switches in a horizontal row at the same time, connecting two transmitters to the same remote unit, and damaging the transmitters. One foolproof way to prevent turning more than one switch at a time is to do all transmitter switching with only one hand.

REMOTE CONTROL UNIT

To operate a transmitter from a remote location requires a remote-control unit. A typical remote-control unit, commonly called RPU (radiophone unit), is type C-1138A/UR shown in figure 9-38. This unit contains a start-stop switch for turning the transmitter on or off, jacks for connecting a handset or chest-set, microphone, headphones, or telegraph key, a volume control for the headphones, and indicator lamps for transmitter-on and carrier-on indications.

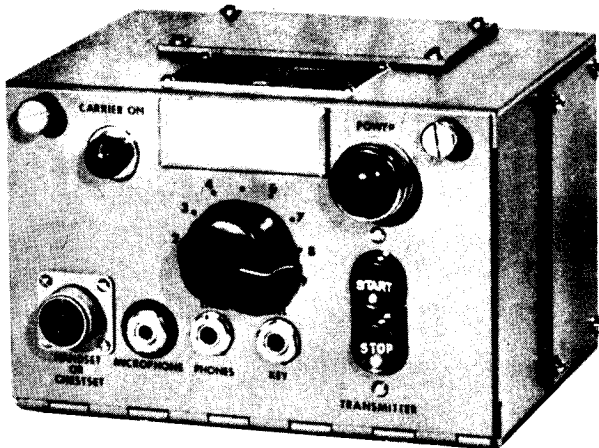

7.40.2A

Figure 9-38. — Radiophone unit (RPU).

DUMMY ANTENNAS

Under radio silence conditions, placing a carrier on the air during transmitter tuning would give an enemy the opportunity to take direction-finding bearings and determine the location of the ship.

Even though radio silence is not imposed, DNC 5 directs that transmitters be tuned by methods that do not require radiation from the

antenna, in order to minimize interference to other stations using the circuit.

One way to tune a transmitter without causing unwanted radiation is through use of previously determined and recorded calibration settings for the tuning controls.

Another method is the use of a dummy antenna. Dummy antennas (called dummy loads) have resistors that dissipate the r-f energy in the form of heat and prevent radiation by the transmitter during the tuning operation.

One model, typical of most dummy loads, is the DA-91/U (fig. 9-39), which can be used with transmitters up to 500 watts. It is enclosed in a metal case that has fins to increase its air-cooled surface area. The dummy load, instead of the antenna, is connected to the output of the transmitter, and the normal transmitter tuning procedure is followed. Use of the dummy load with transmitters such as AN/SRT-15 requires manual disconnection of the transmission line at the transmitter, and connection of the dummy load. Upon completion of transmitter tuning, the dummy load is disconnected and the antenna transmission line is connected again to the transmitter.

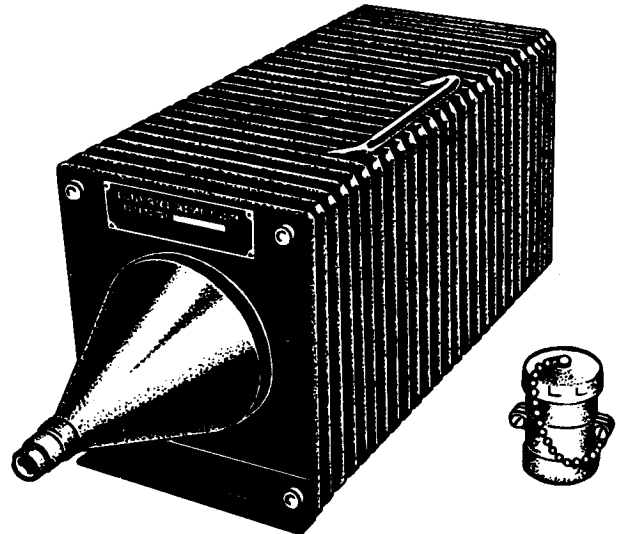

36.29

Figure 9-39. — Dummy antenna, DA-91/U.

Some Navy transmitters, such as the URC-32, have built-in dummy antennas. This arrangement permits connection of either the dummy antenna or the actual antenna by simply throwing a switch.

## RECEIVING ANTENNA DISTRIBUTION SYSTEMS

Various types of shipboard receiving-antenna distribution systems are in use. Some systems are for small ships and special applications only. Filter-type multicouplers are explained in this chapter. Additional information about antenna distribution systems may be found in Shipboard Antenna Details, NavShips 900121(A).

### FILTER ASSEMBLY SYSTEM

A receiving-antenna distribution system using a filter assembly is shown in figure 9-40. This type of distribution system makes possible the multiple operation of a maximum of 28 radio receivers from a single antenna. It is generally preferable, however, to limit the total number of receivers to seven.

The filter assembly, or multicoupler, provides seven radiofrequency channels in the frequency range from 14 kc to 32 mc. Any or all of these channels may be used independently of, or simultaneously with, any of the other channels. Connections to the receivers are made by coaxial patch cords.

An external view of the filter assembly is shown in part B of figure 9-40. Separation of the frequency range into channels is accomplished by combinations of filter subassemblies, which plug into the main chassis. Each filter subassembly consists of complementary high-pass and low-pass filter sections, the common crossover frequency of which marks the division between channels.

The filters not only guard against interference at frequencies falling outside the channel being used, but also prevent receivers connected to alternate rows of jacks from interacting with each other when their tuning and trimming adjustments are made.

A set of nine filter subassemblies is furnished with the equipment, but only six of them may be installed at one time. The six filters installed are selected to cover the most-used frequency bands. The filter subassemblies are sealed units having terminal plugs for easy installation or removal. The filters have numbers stamped on them to indicate their crossover frequencies. These numbers are viewed through windows in the front panel. The six subassemblies that are used are mounted in the order of decreasing frequencies from left to right, as viewed from the front of the panel.

The filter panel (fig. 9-40(B)) contains 1 antenna input jack, 28 output jacks, 21 decoupling resistors, and 6 octal sockets. The antenna input jack and the 28 output jacks are quick-disconnect type r-f connectors. The filter subassemblies plug into octal sockets in the rear of the main chassis (not shown in the illustration).

The bottom jack in each vertical row of output jacks is painted red to indicate that it is connected directly to its subassembly. The other three output jacks in each row are unpainted to denote that they are decoupled from their corresponding filters by 300-ohm decoupling resistors (fig. 9-40(C)).

Because Navy communication receivers generally operate throughout frequency bands that exceed the bandwidths of the filter channels, a given receiver must be connected to the particular row of output jacks that provides the signals of the desired frequency. For example, if the receiver tuning is changed from a frequency in the 7- to 14-mc band to some frequency in the 14- to 32-mc band, the patch cord would have to be moved from the output of the 14- to 7-mc filter unit to the output of the 32- to 14-mc filter unit.

The red-painted jacks at the bottom of each row are directly connected to the filter subassemblies and should be used whenever maximum signal strength is desired. The other three jacks in each row are decoupled by 300-ohm resistors and are best suited for use with relatively strong signals, because a certain amount of signal loss is inevitable. In the ideal arrangement, only one receiver is connected to each vertical row of jacks, and that receiver is connected to the bottom jack in each row. This means that seven receivers are fed from one antenna. At frequencies somewhat removed from the crossover points, the performance of each of these seven receivers should be comparable with that obtained if each receiver were connected to a separate antenna.

### TRANSMITTING ANTENNA MULTICOUPLERS

Antenna multicouplers are used also with transmitting antennas because the many transmitters installed in modern ships make it difficult to find suitable locations for the necessary additional antennas. Multicouplers permit the simultaneous operation of a number of transmitters into a single antenna. Thus, the number of antennas can be reduced without sacrificing any of the required communication

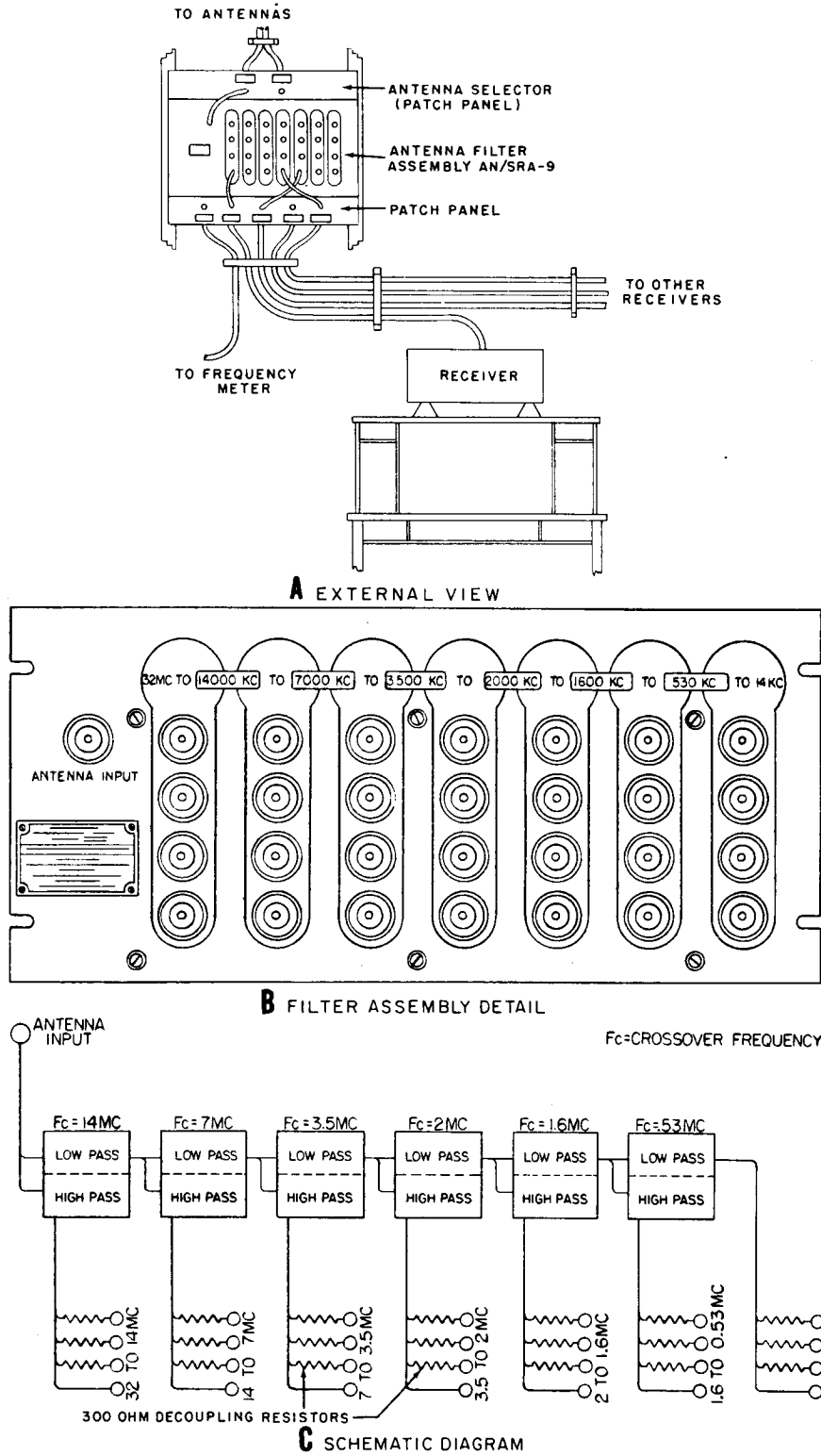

Figure 9-40. —Receiving antenna distribution system, using antenna filter assembly. 1.51:115



channels. This arrangement permits maximum use of the best available antenna locations and reduces the intercoupling between antennas.

Much research and development are being done on multicouplers, and various types have been designed to cover different frequency ranges and to operate with different transmitter models. The information on multicouplers given in this section is of a general nature. Improvements are continually being made, and the equipments described will eventually become obsolete. This is essentially true of all electronic equipment.

### VHF-UHF MULTICOUPLERS

One type of VHF-UHF multicoupler (CU-255/UR) is shown in figure 9-41. When six units are used (as shown), a system is provided for operating six transmitters (or transmitter-receiver combinations) into a single antenna. One coupler is required for each transmitter, or transmitter-receiver combination. The frequency range of this particular multicoupler is 230 to 390 mc.

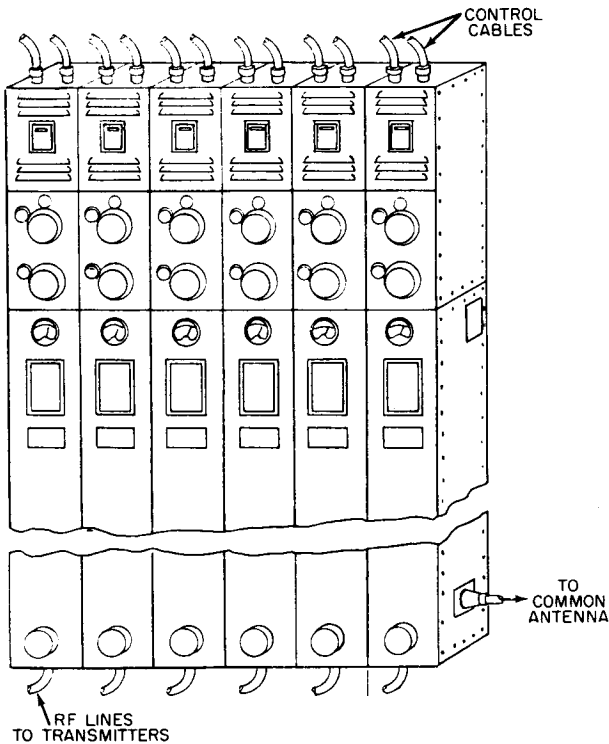

1.266

Figure 9-41. — VHF-UHF multicoupler CU-255/UR.

These couplers can be tuned manually to any frequency in this range. When used with automatic tuning transmitters, such as AN/GRC-27, they may be tuned automatically to any one of 10 preset channels in this band by dialing the desired channel locally on the transmitter or on a remote channel-selector unit.

Correct adjustment of the tuning controls is indicated by the meter on the front panel of the multicoupler. This meter indicates the output from the reflectometer, which is a device for indicating the magnitude of the power reflected back from the coupling circuit. When the controls are adjusted so that the tuning indicator reads zero, the system impedances are properly matched and there is minimum reflected power in the system.

Type CU-332A/UR multicoupler (not shown) is identical to the CU-255/UR just described except for the drive mechanism. The CU-332A/UR provides for manual tuning only, whereas the other has both automatic and manual tuning.

The CU-332A/UR multicoupler is used with manually tuned UHF equipment, such as the model TED transmitter, or any other manually tuned equipment operating in the 230- to 390-mc frequency range.

The performance characteristics of VHF-UHF multicouplers require that operating frequencies on the common antenna be separated by approximately 15 mc.

### HF MULTICOUPLERS

A system of high-frequency antenna multicouplers has been developed for simultaneously operating up to four transmitters into the same antenna in the frequency range of 2 to 26 mc. These antenna couplers are made up into four channel groups, each group operating in one of the following bands: 2-6 mc, 4-12 mc, 6-18 mc, and 9-26 mc. To obtain complete coverage from 2 to 26 mc, four coupler groups and four broad-band antennas are required. These equipments are included here to illustrate the trend toward multicouplers in the HF band.

Four types of HF multicouplers are the AN/SRA-13, -14, -15, and -16. The AN/SRA-15 coupler, which is typical of this group, is illustrated in figure 9-42. It provides for the simultaneous operation of four transmitters (each with 500 watts output) into a single broad-band antenna. It covers the frequency range from 6 to 18 mc. The four transmitters

connected to this multicoupler may be operated anywhere in the frequency range from 6 to 18 mc, as long as there is sufficient separation between the operating frequencies. Ten percent of the highest operating frequency is considered sufficient separation.

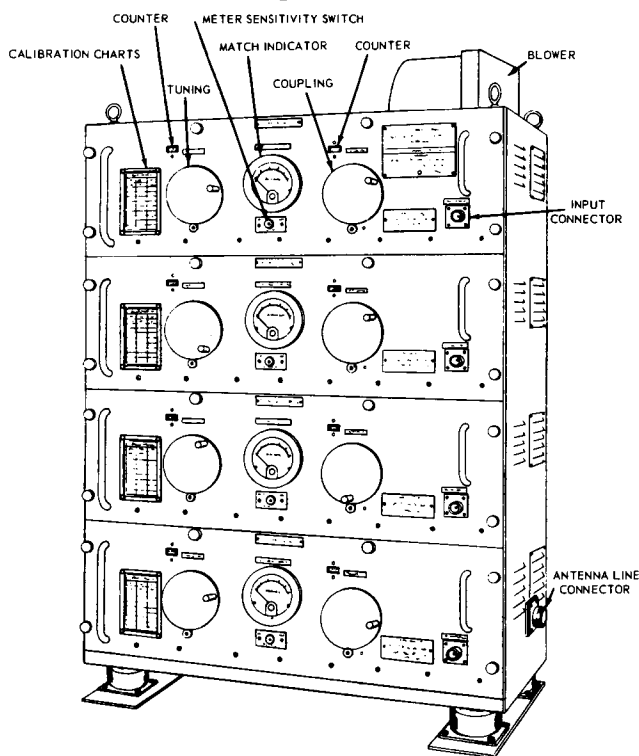

70.28

Figure 9-42. — Antenna multicoupler AN/SRA-15.

## FREQUENCY METERS

Frequency meters are used to tune transmitters and receivers and to determine the frequency of received signals. Two frequency meters used on shipboard for many years are Navy models LM and LR.

### MODEL LM FREQUENCY METER

Several models of this meter have been built. These models are similar except for the power supply and some minor mechanical differences. The LM-18 frequency meter provides a simple, accurate means of adjusting transmitters and receivers to any desired frequency in the range from 125 kc to 20 mc. It is used both as a heterodyne frequency meter for transmitter adjustment, and as a signal source for receiver calibration.

The LM-18 is accurate within .02 percent in the 125- to 2000-kc band, and within .01 percent in the 2000-kc to 20-mc band.

Before any frequency adjustments may be made, the heterodyne oscillator must always be corrected to calibration, through comparison with the crystal oscillator at the crystal checkpoint nearest to the desired frequency. Crystal checkpoints are shown in the equipment calibration book. Comparison between the crystal and heterodyne oscillators may be made at many points over the calibrated range through use of the fundamental or harmonic frequencies of either or both oscillators. Comparison between the two oscillators is made by setting the heterodyne oscillator tuning checkpoint to the scale reading for the crystal checkpoint desired, and adjusting the resulting beat note heard in a pair of headphones. As this adjustment is made, one or more beat notes will be heard in the phones. A corrector control is provided to produce zero beat (no sound) at the strongest beat point within its range. (Zero beat is obtained when both oscillators are tuned to the same frequency and their signals are canceling each other.) After the operator has become familiar with the equipment, it will be found that this adjustment can be made precisely to zero beat. Here is a brief listing of the operating instructions.

To tune a transmitter to a desired frequency:

1. Plug phones into the frequency meter jack.
2. Find page in the calibration book showing dial setting for desired frequency.
3. With crystal switch on, turn frequency meter dial to setting for crystal checkpoint printed in red at bottom of page in the calibration book.
4. Adjust corrector control to obtain zero beat in the phones.
5. Turn crystal switch off.
6. Turn frequency meter dial to setting for desired frequency.
7. With transmitter coupled to the frequency meter, tune transmitter to obtain an audible signal in the phones.
8. Adjust radiofrequency coupling control to obtain sufficiently strong signal.
9. Tune transmitter to obtain zero beat in the phones.

To tune a CW receiver to a desired frequency:

1. Adjust frequency meter to nearest crystal checkpoint, as outlined in the preceding steps 1 through 5.

2. Turn the frequency meter dial to setting for desired frequency.
3. Remove the phones from frequency meter, and plug them into the receiver output jack.
4. With the receiver coupled to the frequency meter, tune the receiver to obtain an audible signal in the phones.
5. Adjust the radiofrequency coupling control to obtain sufficient signal.
6. Tune the receiver to obtain zero beat in the phones.

#### LR FREQUENCY METER

Model LR frequency meter has greater accuracy and a greater frequency range than the model LM just described. Model LR is used for setting transmitters and receivers to desired frequencies in the range 160 kc to 30 mc. By harmonic extension, frequencies up to 60 mc can be measured. The equipment is accurate within .003 percent.

A newer model, known as model FR-36/U, is similar in all essential details to the earlier LR models.

#### AN/URM-82 FREQUENCY METER

One of the frequency meters now replacing older models is AN/URM-82, shown in figure 9-43. The AN/URM-82 is a precision instrument for measuring frequencies in the range of 100 kc to 20 mc. It is used also to calibrate radio transmitters to an accuracy of .001 percent. Features of the AN/URM-82 include a blinker light in addition to earphones to provide visual as well as aural indications of zero beat settings; a built-in oscilloscope is used to aid in setting the internal oscillator frequency.

The calibration book is fastened to a drawer that slides under the cabinet when not in use.

#### EMERGENCY AND PORTABLE EQUIPMENT

Several models of portable radio equipment are in the Navy today. Included here are two of them, transceiver AN/GRC-9, and lifeboat transmitter AN/CRT-3.

#### TRANSCEIVER AN/GRC-9

Radio set AN/GRC-9 is a low-power radio transmitter and receiver, shown in figure

9-44. It can be used in either vehicular or ground installations. It is carried aboard ship for use by landing parties in communicating with the ship.

The AN/GRC-9 receives and transmits CW, MCW, and a-m radiotelephone signals in the 2- to 12-mc frequency range. There are provisions for six crystal-controlled channels, with master oscillator tuning also available for any frequency within the band.

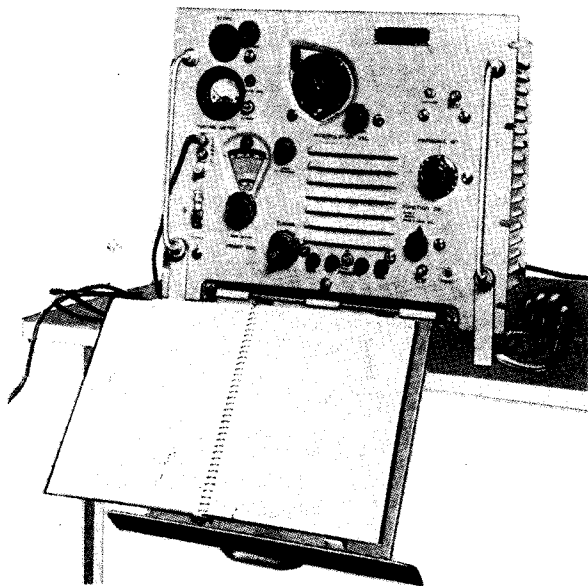

76.30

Figure 9-43. — Frequency meter AN/URM-82.

For different kinds of installations, the radio set can be operated with batteries, dynamotors, gasoline-driven generators, or hand-driven generators.

The output power of the transmitter varies somewhat depending upon the type of power supply used. When powered by the hand-driven generator, the output is approximately 10 watts CW and 4 watts on phone. Reliable communication range is usually about 30 miles for CW and 10 miles for phone. These values are approximations, because the range will vary considerably according to terrain, atmospheric conditions, frequencies, and time of day, month, and year.

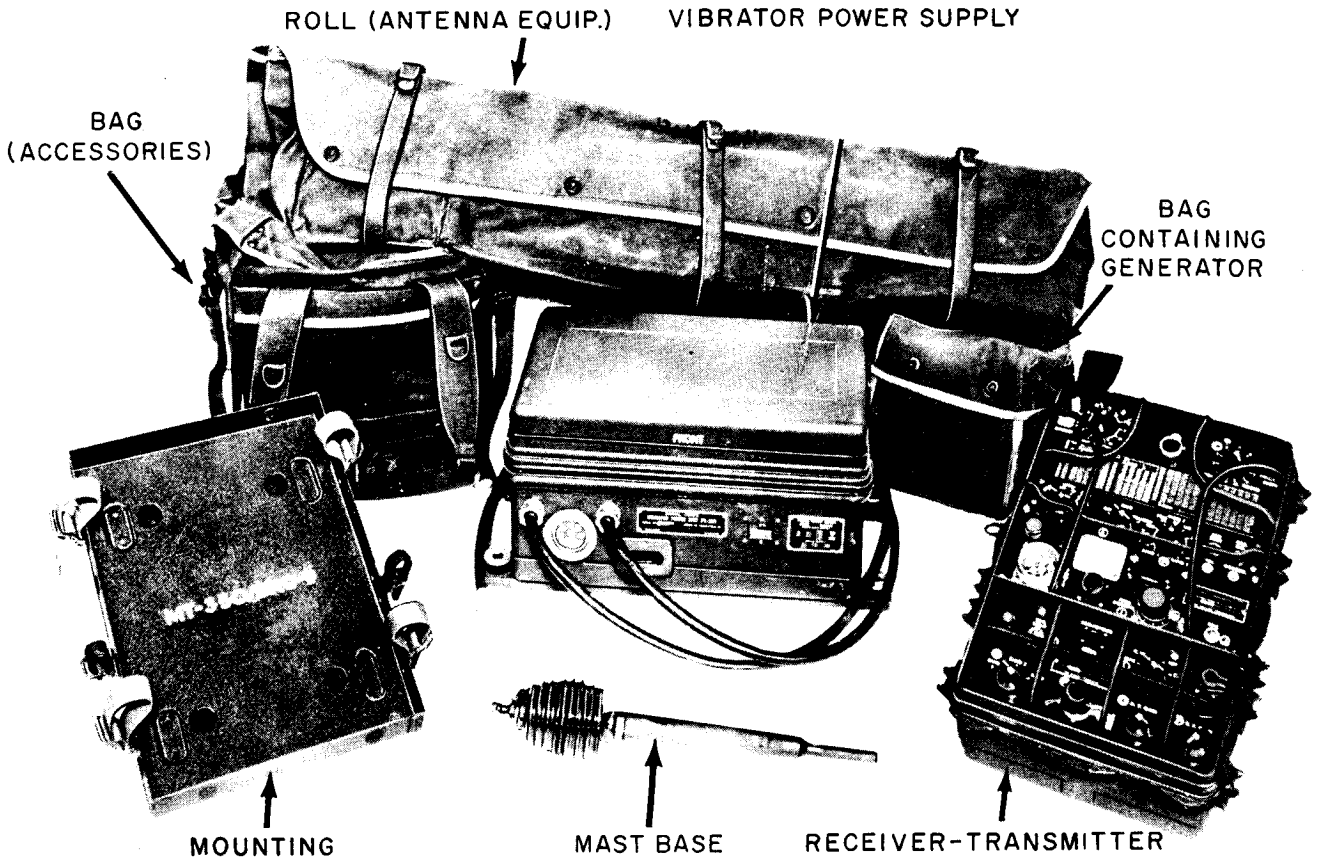

76.31

Figure 9-44. — Components of Radio Set AN/GRC-9.

The receiver and transmitter are contained in a metal case that has a tight-fitting removable cover. These components are dirtproofed and waterproofed for complete protection while transporting the equipment and when operating under extremely adverse weather conditions.

cabinet that is airtight and waterproof. The cabinet is shaped to fit between the operator's legs and it has a strap for securing it in the operating position.

**LIFEBOAT TRANSMITTER AN/CRT-3**

Radio transmitter AN/CRT-3, popularly known as the "Gibson girl," is a rugged emergency transmitter carried aboard ships and aircraft for use in lifeboats and rafts. It is shown in figure 9-45. No receiving equipment is included.

The transmitter operates on the international distress frequency, 500 kc, and the survival craft communication frequency, 8364 kc. (Uses of these and other distress frequencies are explained in chapter 6.)

The complete radio transmitter, including the power supply, is contained in an aluminum

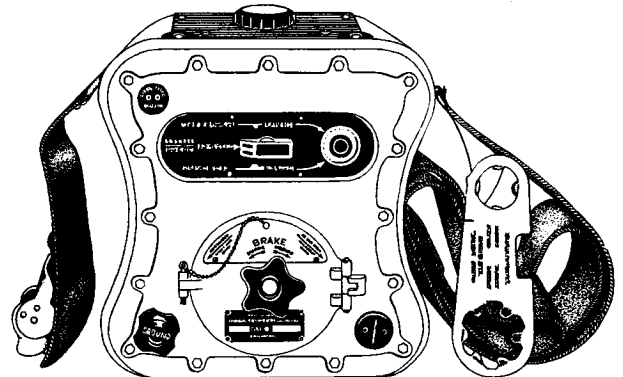

76.32

Figure 9-45. — Emergency lifeboat transmitter AN/CRT-3.

The only operating controls are a three-position selector switch and a pushbutton telegraph key. A handcrank screws into a socket in the top of the cabinet. The generator, automatic keying, and automatic frequency changing are all operated by turning the handcrank. While the handcrank is being turned, the set automatically transmits the distress signal SOS in Morse code. The code sequence consists of six groups of SOS followed by a 20-second dash, transmitted alternately on 500 kc and 8364 kc. The frequency automatically changes every 50 seconds. These signals are intended for reception by two groups of stations, each having distinct rescue functions. Direction-finding stations cooperating in long-range rescue

operations generally make use of 8364 kc, whereas aircraft or ships locally engaged in search and rescue missions make use of the 500 kc signals.

Besides the automatic feature, the transmitter can be keyed manually, on 500 kc only, by means of the pushbutton telegraph key.

Additional items (not shown) packaged with the transmitter include the antenna, a box kite and balloons for supporting the antenna, hydrogen-generating chemicals for inflating the balloons, and a signal lamp that can be powered by the handcrank generator.

The equipment will float and it is painted brilliant orange-yellow to provide greatest visibility against dark backgrounds.